

Summer 2024

# Pondkeeper

## SUMMER SALE



Solar Water Features

See Pg 2

**NEW**



**Free** P&P on all orders over £40 - Quote code "SALE24"

[pondkeeper.co.uk](http://pondkeeper.co.uk) | 01642 370888

**Open Now**  
**BARGAINS**  
Inside

# New Solar Water Features

**ZERO RUNNING COSTS • HALF PRICE RRP • USE INDOOR OR OUT • EASY ASSEMBLY**

All PondXpert SolarFalls water features include: solar pumps (battery-back up), hose and LED lights

**pondXpert**  
**SolarFalls**



### TripleTumble

39x39x72cm (LWH)  
Inc. 300LPH Pump.

RRP £299.99  
**Our Price £149.99**

### Terracotta Cascade

32x32x53cm (LWH)  
Inc. 200LPH Pump.

RRP £199.99  
**Our Price £99.99**



### Elegance Classical Fountain

58x58x86cm (LWH)  
Inc. 300LPH Pump.

RRP £379.99  
**Our Price £189.99**



### Contemporary BirdBath

41x39x71cm (LWH)  
Inc. 300LPH Pump.

RRP £339.99  
**Our Price £169.99**



### Accessories

200lph 5v Mains Adapter **£9.99**

300lph 9v Mains Adapter **£12.99**

PondXpert Water Feature Cleaner **£12.99**



Welcome to your copy of our Sizzling Summer Sale Catalogue.

Make the most of the summer ahead with your new Catalogue packed with **NEW** items and fantastic **SALE** deals!

Director, Founder & Proud Pondkeeper  
Stephen Armstrong

*S. Armstrong*

Your feedback is greatly appreciated. We now have over **3750 products** reviewed & rated on our website. This helps newcomers to the hobby to decide what to buy and lets us know what products to keep in our range. Also, your comments regarding your buying experience with us help us to maintain a high level of service.



Over **29,000** customer reviews now shared online. We recently received a Platinum Trusted Service 2023 award. Awarded for achieving Gold Trusted Service for the past three consecutive years.

\* Reviews correct at time of going to press



Contents	Page
<b>POND FILTRATION SETS</b>	6-11
<b>PREFORM/RAISED PONDS</b>	12-17
<b>PEBBLE PONDS</b>	18
<b>FISH VIEWING TOWERS</b>	19
<b>SHED ROOFING KITS</b>	20
<b>POND LINERS</b>	21-26
<b>WATERCOURSES</b>	27-30
<b>POND PUMPS</b>	31-53
All-in-One	31-33
Feature/Fountain	34-37
Solar Pumps	38-45
Filter Pumps	47-53
<b>POND FILTERS</b>	54-65
Gravity/Box Filters	56-57
Pressure Filters	58-61
Koi Filters	62-65
<b>CLEANING TOOLS</b>	66-75
Pond Vacuums	71-75
<b>UV UNITS &amp; BULBS</b>	76-79
<b>PONDSIDE ELECTRICS</b>	80
<b>POND AIR PUMPS</b>	81-85
<b>HERON DETERRENT</b>	86-87
<b>WATER TREATMENTS</b>	88-97
<b>FISH FOOD &amp; FEEDERS</b>	98-102
<b>ORNAMENTAL CREATURES</b>	103
<b>POND LIGHTING</b>	104-107
<b>POND PLANTS</b>	108-112
<b>HOSE &amp; FITTINGS</b>	113-115

### So Easy To Order



### Online

Secure 24/7 ordering  
[www.pondkeeper.co.uk](http://www.pondkeeper.co.uk)



### Phone

Our friendly team are ready to take your order **01642 370888**

8am - 6pm March to September 30th.  
9am - 5pm October to February.

### Visit/Shop

Sales counter in Billingham near Middlesbrough. Drop in anytime.

**Now Open Sat. 9-5 & Sun. 10-4**

Weekends Spring/Summer only

### Post

Cheques or credit card numbers to:  
**Pondkeeper**, A3 Bentley Avenue,  
Billingham. TS23 4BU  
Make payable to 'pondkeeper'

### Claim Your Special Offer

Quote code to trigger offer.

\*Minimum spend excludes P&P. Offers expire 31/8/24.  
Not to be used in conjunction with any other offers.

# Coming Soon...

Here at Pondkeeper we are constantly looking for new exciting aquatic items to bring to your attention.

New stock lines arrive weekly!

We know you like to be kept up-to-date with all of the latest exciting pond products.

Here's a sneak preview of new products arriving next month.

## PondXpert SolarFalls Water Features

### SolaBall Sandstone

22 x 22 x 61cm (LWH)

RRP £219.99

Our Price **£109.99**



### SolaBall Grey

27 x 27 x 56cm (LWH)

RRP £199.99

Our Price **£99.99**



All these features include SolarShower 200 Pump see pg 41

**NEW**

### Stepped Frog Cascade

45 x 36 x 64cm (LWH)

RRP £239.99

Our Price **£119.99**



### Cascading Jugs

22 x 22 x 61cm (LWH)

RRP £299.99

Our Price **£149.99**

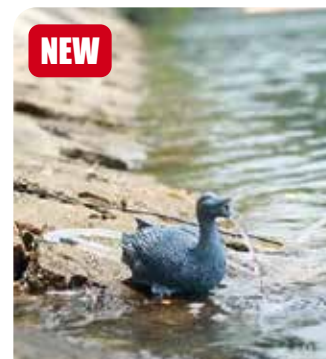

**NEW**

### Duck Spitter

13 x 23 x 17cm (LWH)

RRP £49.99

Our Price **£24.99**



**NEW**

### Turtle Spitter

16 x 23 x 11cm (LWH)

RRP £49.99

Our Price **£24.99**



**NEW**

### PondXpert Solar Float 180

Floating Solar Fountain  
2.5 Watt Solar Panel  
White LEDs (6)  
Five fountain choices  
Lithium Battery 3.7V 600mAh  
Max Flow 180 LPH  
Max Fountain Height 50cm

RRP £69.99

Our Price **£34.99**

Includes optional fittings to secure fountain in centre of birdbath

## Frog & koi Spitters Back by popular demand!



### Koi Spitter (Large)

42 x 18 x 27cm (LWH)

RRP £79.99

Our Price **£39.99**



### Sitting Frog Spitter

17 x 21 x 22cm (LWH)

RRP £49.99

Our Price **£24.99**

All PondXpert Spitters supplied with 8mm & 12mm hose (1.5m lengths)

All products on these two pages due to arrive by Late July 2024

# EasyPond Sets

## Box Filter Sets

The Classic Filtration System



The easy way to buy your pond hardware

Save up to £306.66\*

Pump supplied different to image, see table below

COMPLETE FILTER SYSTEMS - everything you need

Filter Pump, Pond Hose, UVC Filter, Clips



Model	Filter Model Size	Pump Size LPH	Usual Price*	OUR PRICE	Save	Pond Dimensions			Complete Kit	
						L (m/ft)	W (m/ft)	D (m/ft)	Liner & Underlay	SALE PRICE
EasyPond Box 6000	6000	3000	£218.46	<b>£149.99</b>	£68.47	3.7 / 12'	2.5 / 8'2"	0.6 / 2'	5 x 5m	<b>£229.99</b>
EasyPond Box 12000	12000	6000	£353.46	<b>£249.99</b>	£103.47	4.0 / 13'	3.0 / 10'	0.6 / 3'	7 x 6m	<b>£329.99</b>
EasyPond Pro 9000	9000	6000	£433.45	<b>£309.99</b>	£309.46	3.0 / 10'	3.0 / 10'	1 / 3'	6 x 6m	<b>£449.99</b>
EasyPond Pro 18000	18000	10000	£573.45	<b>£429.99</b>	£429.46	5.0 / 16'5"	3.0 / 10'	1 / 3'	8 x 6m	<b>£619.99</b>
EasyPond Pro 36000	16000	16000	£713.45	<b>£539.99</b>	£539.46	7.0 / 23'	5.0 / 16'5"	1 / 3'	10 x 8m	<b>£869.99</b>

### Components Supplied

EasyPond Box 6000: Pump - PondXpert MightyMite 3000 (pg 47) Filter - PondXpert FiltoBox 6000 with 9w UVC (pg 56)

EasyPond Box 12000: Pump - PondXpert UltraFlow 6000 (pg 49) Filter - PondXpert FiltoBox 12000 with 18w UVC (pg 56)

All Sets include 25mm (1") Pond Hose x 5m (16') plus a pair of 25mm clips. Liner Sets include Flexiliner 40yr plus Basic Underlay.

## EasyPond Box Pro

NEW



MultiChamber 9000



MultiChamber 18000



MultiChamber 36000



GreenStop PRO 36W UVC



### EasyPond Box PRO Sets Components Supplied

EasyPond Box PRO 9000: Pump - PondXpert UltraFlow 6000 (pg 49) Filter - PondXpert MultiChamber 9000 with 36w UVC (pg 65)

EasyPond Box PRO 18000: Pump - PondXpert UltraFlow 10000 (pg 49) Filter - PondXpert MultiChamber 18000 with 36w UVC (pg 65)

EasyPond Box PRO 36000: Pump - PondXpert UltraFlow 16000 (pg 49) Filter - PondXpert MultiChamber 36000 with 36w UVC (pg 65)

All Sets include 25mm (1") Pond Hose x 5m (16') plus a pair of 25mm clips. Liner Sets include Flexiliner 40yr plus Fleece Underlay.

# EasyPond Sets

## Pressure Filter Sets

Maximise your landscaping options

Save up to £216.13\*



## The Best Value Entry - Level Systems

If you are looking for extra features simply turn the page . . .

Add a Pond Liner to Set SAVE even more!

Pump and filter sets

Exclusive

\* Cost of buying set products individually

Complete Pond Kits

Model	Filter Model Size	Pump Size LPH	Usual Price*	SPECIAL PRICE	Pond Dimensions			Volume		Liner and Underlay	Usual Price*	SPECIAL PRICE
					L (m/ft)	W (m/ft)	D (m/ft)	Litres	Gallons			
EasyPond 2000	4500	2000	£177.95	<b>£109.99</b>	2.0 / 6' 6"	1.7 / 5'6"	0.6 / 2'	2040	450	4 x 3m	£235.43	<b>£159.99</b>
EasyPond 3000	4500	2500	£182.95	<b>£119.99</b>	2.5 / 8'	2.0 / 6'6"	0.6 / 2'	3000	660	4 x 4m	£259.59	<b>£184.99</b>
EasyPond 4500	4500	3000	£192.95	<b>£129.99</b>	3.4 / 11'	2.2 / 7'3"	0.6 / 2'	4488	1000	5 x 4m	£288.75	<b>£209.99</b>
EasyPond 7000	9000	3500	£237.95	<b>£154.99</b>	3.4 / 11'	3.4 / 11'	0.6 / 2'	6936	1500	5 x 5m	£357.70	<b>£264.99</b>
EasyPond 8000	9000	4500	£247.95	<b>£164.99</b>	4.0 / 13'	3.4 / 11'	0.6 / 2'	8160	1800	6 x 5m	£391.65	<b>£289.99</b>
EasyPond 9000	9000	6000	£297.95	<b>£189.99</b>	3.0 / 10'	3.0 / 10'	1.0 / 3'	9000	2000	6 x 6m	£470.39	<b>£344.99</b>
EasyPond 10000	12000	6000	£327.95	<b>£219.99</b>	3.3 / 11'	3.0 / 10'	1.0 / 3'	9900	2200	6 x 6m	£500.39	<b>£369.99</b>
EasyPond 12000	12000	8000	£347.95	<b>£234.99</b>	4.0 / 13'	3.0 / 10'	1.0 / 3'	12000	2500	7 x 6m	£549.13	<b>£399.99</b>
EasyPond 20000	20000	12000	£444.35	<b>£299.99</b>	4.5 / 15'	4.5 / 15'	1.0 / 3'	20250	4500	7.5 x 7.5m	£713.79	<b>£529.99</b>
EasyPond 30000	30000	15000	£514.35	<b>£349.99</b>	6.7 / 23'	4.6 / 13'	1.0 / 3'	28000	6200	9 x 7m	£816.12	<b>£599.99</b>

## Choose the Right Pond for your Garden

### EasyPond Depths & Fish Stocking Information

**Smaller Sets** (EasyPond 2000-8000) suggested max. depth 60cm (2 ft). Ideal ornamental or goldfish ponds.

**Larger Sets** (9000-30000) suggested max. 1m (3' 3") depth. Suitable for higher fish levels and/or koi.

There are no limits to a pond size. This information is given as a guide only. For other pond sizes please get in touch with your dimensions and we can help.

**Pump Detail** All handle solids and can run 24/7.

Set Name	Pond Pump Included
EP2000-4500	PondXpert MightyMite (pg 47)
EP7000-8000	PondXpert Flowmaster (pg 37)
EP9000-30000	PondXpert UltraFlow (pg 49)

### Liner & Underlay Detail

Liner Sets Include Flexiliner 40yr and Basic Underlay

### Hose & Clips Detail

Sets include 5m pond hose & 4 x clips 25mm (20/30000 32mm)

**Filter Detail** All sets include a PondXpert EasyFilter (pg 58)



Includes all hose, clips and fittings



EasyPond 2000

← 6.5 ft →

↓ 2 ft



EasyPond 3000

← 8 ft →

↓ 2 ft



EasyPond 4500

← 11 ft →

↓ 2 ft



EasyPond 7-8000

← 10-13 ft →

↓ 2 ft



EasyPond 9-12000

← 10-13 ft →

↓ 3 ft

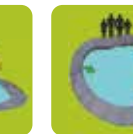

EasyPond 20000

← 15 ft →

↓ 3 ft

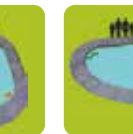

EasyPond 30000

← 23 ft →

↓ 3 ft

# EasyPond Plus Sets

## Pressure Filter Sets

Maximise your landscaping options

- Perfectly matched components!
- Save £££'s



The **Secret** Behind every Successful Pond . . .



. . . is selecting an effective pump and filter system.



# EasyPond Plus Sets

## Pressure Filter Sets

Maximum Choice - Maximum Spec - Best Deal!

Taking easy pondkeeping to a new level!

Save up to **£376.13\***

Add a Pond Liner to Set **SAVE** even more!

Maximise your landscaping options

Pump and filter sets		<b>Exclusive</b>		* Cost of buying set products individually						Complete Pond Kits		
Model	Filter Model Size	Pump Size LPH	Usual Price*	DEAL PRICE	Pond Dimensions			Volume		Liner and Underlay	Usual Price*	DEAL PRICE
					L (m/ft)	W (m/ft)	D (m/ft)	Litres	Gallons			
EasyPond+ 2000	4500	2000	£217.95	<b>£159.99</b>	2.3 / 7' 6"	1.3 / 4' 3"	0.6 / 2'	1794	395	4 x 3m	£275.43	<b>£191.99</b>
EasyPond+ 3000	4500	2500	£222.95	<b>£169.99</b>	2.3 / 7' 6"	2.3 / 7' 6"	0.6 / 2'	3174	699	4 x 4m	£299.59	<b>£215.99</b>
EasyPond+ 4500	4500	3000	£232.95	<b>£179.99</b>	3.2 / 10' 6"	2.3 / 7' 6"	0.6 / 2'	4416	973	5 x 4m	£328.75	<b>£239.99</b>
EasyPond+ 6000	6000	3600	£297.95	<b>£229.99</b>	3.2 / 10' 6"	3.2 / 10' 6"	0.6 / 2'	6144	1353	5 x 5m	£417.70	<b>£299.99</b>
EasyPond+ 8000	8000	5300	£347.95	<b>£259.99</b>	4.0 / 13' 2"	3.3 / 10' 2"	0.6 / 2'	7920	1744	6 x 5m	£491.65	<b>£335.99</b>
EasyPond+ 9000	12000	6000	£397.95	<b>£289.99</b>	3.9 / 12' 9"	3.9 / 12' 9"	0.6 / 2'	9126	2010	6 x 6m	£570.39	<b>£383.99</b>
EasyPond+ 12000	12000	8000	£417.95	<b>£309.99</b>	5.0 / 16' 5"	4.0 / 13' 2"	0.6 / 2'	12000	2643	7 x 6m	£619.13	<b>£419.99</b>
EasyPond+ 20000	20000	12000	£514.35	<b>£369.99</b>	5.4 / 17' 8"	3.6 / 11' 9"	1.0 / 3'	19440	4282	8 x 6m	£744.27	<b>£479.99</b>
EasyPond+ 25000	30000	14000	£644.35	<b>£479.99</b>	5.0 / 16' 5"	5.0 / 16' 5"	1.0 / 3'	25000	5507	7.5 x 7.5m	£913.79	<b>£575.99</b>
EasyPond+ 30000	40000	16000	£734.35	<b>£549.99</b>	6.5 / 21' 3"	4.5 / 14' 9"	1.0 / 3'	29250	6443	9 x 7m	£1036.12	<b>£659.99</b>

### Pump/Filter Systems with Best Specification

Save up to **£37%** versus buying items separately!

Our exclusive EasyPond+ Sets are a proven hit with our customers. These new sets are for those customers wanting to utilise features found on the latest equipment.

### Introducing EasyPond+ Sets

Building on the EasyPond heritage - again a comprehensive range of Sizes to suit every garden. But now the feature count has been extended:

- PondXpert SpinClean Filters boast easyclean technology reducing maintenance.
- PondXpert UltraFlow Pumps boast class-leading performance (6000 set up)
- MightyMite Pumps sets mean easy-clean filtration sets now can be achieved in the smaller ponds at a low prices. (2000 / 3000 / 4500 sets).

Sets include 5m pond hose and 4 clamps. (25mm for smaller systems, 32mm for systems 20000-30000). Flexliner 40yr and Pond Fleece Underlay included in complete kits.

EasyPond+ 2000 7'6" x 4'3"	EasyPond+ 3000 7'6" x 7'6"	EasyPond+ 4500 10'6" x 7'6"	EasyPond+ 6000 10'6" x 10'6"	EasyPond+ 8000 13' x 10'	EasyPond+ 12000 16' x 13'
EasyPond+ 20000 17' 8" x 11' 9"	EasyPond+ 25000 16' 5" x 16'5"	EasyPond+ 30000 21' 3" x 14'9"    23' x 16' 5" if only 2' deep			

Smaller pond sizes (2000 to 12000 ltrs) based on a max depth of 0.6m (2') Larger set pond dimensions based on 1m depth (3'3")

### Feature-Packed Pump & Filter Make pondkeeping a joy not a chore!

Further info on components can be found on the following pages:

- MightyMite Pump - Pg 47
- UltraFlow Pump - Pg 49
- SpinClean Filter - pg 60



# EasyPond Auto Sets

## Pressure Filter Sets

Maximise your landscaping options

- Perfectly matched components!
- Save £££'s



**"One Touch"  
Automatic  
Cleaning**



STANDARD SPINCLEAN

EASY  
Turn Handle  
to Clean



AUTO SPINCLEAN

Even EASIER!  
Simply twist control  
dial for motorised  
cleaning

### SpinClean

- Bestseller
- Unique 'Easy Clean' mechanism
- Highly competitive price point
- Reliable

### SpinClean AUTO

- **NEW** Generation with latest technology
- Motorised cleaning process
- Same base features as standard SpinClean
- Additional 'Pro' model for koi-keepers

# EasyPond Auto Sets

## Pressure Filter Sets

Maximum Choice - Maximum Spec - Best Deal!

Taking easy pondkeeping  
to a new level!

Save up to **£567.26\***

Add a Pond Liner to Set  
SAVE even more!

Maximise your landscaping options

Pump and filter sets		* Cost of buying set products individually								Complete Pond Kits		
Model	Filter Model Size	Pump Size LPH	Usual Price*	DEAL PRICE	Pond Dimensions			Volume		Liner and Underlay	Usual Price*	DEAL PRICE
					L (m/ft)	W (m/ft)	D (m/ft)	Litres	Gallons			
EasyPond Auto 2000	4500	2000	£247.95	<b>£189.99</b>	2.3 / 7' 6"	1.3 / 4' 3"	0.6 / 2'	1794	395	4 x 3m	£305.43	<b>£227.99</b>
EasyPond Auto 3000	4500	2500	£252.95	<b>£199.99</b>	2.3 / 7' 6"	2.3 / 7' 6"	0.6 / 2'	3174	699	4 x 4m	£329.59	<b>£239.99</b>
EasyPond Auto 4500	4500	3000	£262.95	<b>£209.99</b>	3.2 / 10' 6"	2.3 / 7' 6"	0.6 / 2'	4416	973	5 x 4m	£358.75	<b>£251.99</b>
EasyPond Auto 6000	6000	3600	£327.95	<b>£259.99</b>	3.2 / 10' 6"	3.2 / 10' 6"	0.6 / 2'	6144	1353	5 x 5m	£447.70	<b>£311.99</b>
EasyPond Auto 8000	8000	5300	£397.95	<b>£299.99</b>	4.0 / 13' 2"	3.3 / 10' 2"	0.6 / 2'	7920	1744	6 x 5m	£514.65	<b>£359.99</b>
EasyPond Auto 9000	12000	6000	£457.95	<b>£339.99</b>	3.9 / 12' 9"	3.9 / 12' 9"	0.6 / 2'	9126	2010	6 x 6m	£630.39	<b>£407.99</b>
EasyPond Auto 12000	12000	8000	£477.95	<b>£359.99</b>	5.0 / 16' 5"	4.0 / 13' 2"	0.6 / 2'	12000	2643	7 x 6m	£679.13	<b>£431.99</b>
EasyPond Auto 20000	20000	12000	£584.35	<b>£449.99</b>	5.4 / 17' 8"	3.6 / 11' 9"	1.0 / 3'	19440	4282	8 x 6m	£814.27	<b>£539.99</b>
EasyPond Auto 25000	30000	14000	£724.35	<b>£589.99</b>	5.0 / 16' 5"	5.0 / 16' 5"	1.0 / 3'	25000	5507	7.5 x 7.5m	£993.79	<b>£707.99</b>
EasyPond Auto 30000	40000	16000	£864.35	<b>£729.99</b>	6.5 / 21' 3"	4.5 / 14' 9"	1.0 / 3'	29250	6443	9 x 7m	£1166.12	<b>£875.99</b>
EasyPond Auto 50000	50000	16000	£1084.35	<b>£939.99</b>	9.0 / 20'	6.0 / 30'	1.0 / 3'	54000	11895	12 x 9m	£1709.87	<b>£1199.99</b>
EasyPond Auto 75000	75000	20000	£1264.55	<b>£1109.99</b>	10.0 / 33'	7.0 / 23'	1.0 / 3'	70000	15419	13 x 10m	£2017.25	<b>£1449.99</b>

Feature-Packed Pump & Filter Make pondkeeping a joy not a chore!

Further info on components can be found on the following pages:









- MightyMite Pump - Pg 47
- UltraFlow Pump - Pg 49
- SpinClean Auto Filter - pg 61
- Auto Pro - pg 63

### Introducing EasyPond Auto Sets

Building on the EasyPond heritage - again a comprehensive range of Sizes to suit every garden. But now the feature count has been extended:

- PondXpert SpinClean Filters boast easyclean technology reducing maintenance.
- PondXpert UltraFlow Pumps boast class-leading performance (6000 set up)
- MightyMite Pumps sets mean easy-clean filtration sets now can be achieved in the smaller ponds at a low prices. (2000 / 3000 / 4500 sets).

Sets include 5m pond hose and 4 clamps. (25mm for smaller systems, 32mm for systems 20000-30000). Flexiliner 40yr and Pond Fleece Underlay included in complete kits.

 EasyPond Auto 2000 7'6" x 4'3"	 EasyPond Auto 3000 7'6" x 7'6"	 EasyPond Auto 4500 10'6" x 7'6"	 EasyPond Auto 6000 10'6" x 10'6"	 EasyPond Auto 8000 13' x 10'	 EasyPond Auto 12000 16' x 13'
 EasyPond Auto 20000 17' 8" x 11' 9"	 EasyPond Auto 25000 16' 5" x 16' 5"	 EasyPond Auto 30000 21' 3" x 14' 9"    23' x 16' 5" if only 2' deep		<i>Smaller pond sizes (2000 to 12000 ltrs) based on a max depth of 0.6m (2') Larger set pond dimensions based on 1m depth (3'3")</i>	



Filters with motorised cleaning

# Pond Building Guide - Preform Ponds



## Filbert Frog's Top Tip

Pre-formed ponds must have good all-round support. Be sure to tamp and compress the sand or soil between the hole and sides of the pond.



**1** Place the pond in position and carefully mark out its shape with stakes. Don't turn the pond upside down to mark out the shape, as this gives a mirror image of the pond and will not match up.

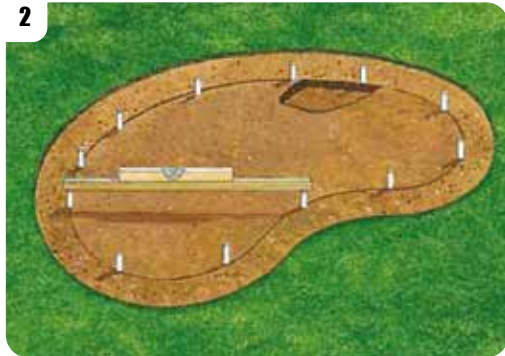

**2** Position the pond right side up in the exact place you want it and use it as a guide or template while digging around the stakes. Make your outline 4-6 inches (10-15cm) larger than the pond itself. Verify the first level and start digging down to the shelves.



**3** Reposition the pond, mark out the inner deeper section and continue digging out to the bottom. Be sure that the hole is slightly deeper than the actual depth of the preformed pond and verify that the pond is level. Remove any loose objects from the hole and add about 2" (5cm) of sand or fine soil to the base level and shelves.



**4** Position the pre-formed pond into the excavation and verify it is level. Back-fill any spaces with sand or soil. Fill with water and leave to settle for at least a week before finishing off with your choice of edging.

# Pond Tanks

## Preformed Ponds - Buried Only

Preformed ponds are the easiest and quickest way to create a garden pond.

- Predetermined shape and depth
- No worries about creased material
- Ideal for poor soil conditions



## PondXpert Preformed Ponds

A new range of durable ponds manufactured from high density polyethylene. Black colour finish and Lifetime Guarantee on all ponds. Models 2 and 3 have a smooth finish whereas the rest of the range are textured. (Note: dimensions include a 5cm Lip/overhang (11cm on 'Goldfish', 8cm on 'Koi').

*\*Textured ponds only*  
Integral wildlife escape route and integral pump stand

Four great shapes to choose from:

- |                  |            |                         |   |                    |
|------------------|------------|-------------------------|---|--------------------|
| <b>1 *Minnow</b> | RRP £59.99 | <b>Our Price £29.99</b> | Dimensions: (LWH cm) 85 x 63 x 29 (2'9" x 2' x 1')      | Volume: 55 Litres  |
| <b>2 Guppy</b>   | RRP £69.99 | <b>Our Price £34.99</b> | Dimensions: (LWH cm) 90 x 65 x 28 (3' x 2'2" x 1")      | Volume: 70 Litres  |
| <b>3 Rudd</b>    | RRP £79.99 | <b>Our Price £39.99</b> | Dimensions: (LWH cm) 102 x 70 x 30 (3'3" x 2'3" x 1")   | Volume: 100 Litres |
| <b>4 *Tench</b>  | RRP £99.99 | <b>Our Price £49.99</b> | Dimensions: (LWH cm) 125 x 84 x 34 (4'1" x 2'9" x 1'1") | Volume: 120 Litres |

The following larger ponds are great value considering they have a 2 man delivery.

- |                    |             |                          |   |                    |
|--------------------|-------------|--------------------------|---|--------------------|
| <b>5 *Goldfish</b> | RRP £199.99 | <b>Our Price £99.99</b>  | Dimensions: (LWH cm) 150 x 110 x 34 (4'11" x 3'7" x 1'1") | Volume: 172 Litres |
| <b>6 *Koi</b>      | RRP £239.99 | <b>Our Price £119.99</b> | Dimensions: (LWH cm) 164 x 122 x 42 (5'4" x 4' x 1'4")    | Volume: 460 Litres |



## - Special Offer -

Half Price All-in-One Pond Pump with any preformed pond purchase. -----  
PondXpert TripleAction 2000 All-in-One Pump (see page 33).

Usually £79.99 **Only £39.99**



# Raised Ponds



Instalog 175 Gallon Shown

## Instalog Wooden Ponds

These pools are all based on an extremely easy to assemble system of interlocking "logs" which slot together and build up in layers thus doing away with the need for specialist fixings.

They are all simple to assemble and disassemble, so you can move them to another part of the garden or patio.

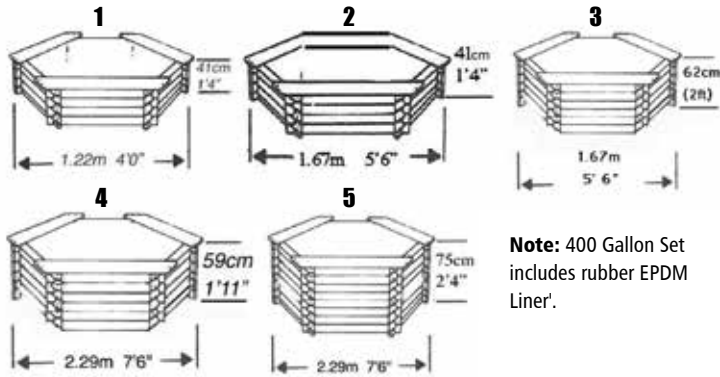

**Note:** 400 Gallon Set includes rubber EPDM Liner.

- 1 50 Gallon (227 litres)**  
RRP £226.12 **Our Price £199.99**
- 2 100 Gallon (454 litres)**  
RRP £312.63 **Our Price £274.99**
- 3 175 Gallon (795 litres)**  
RRP £433.24 **Our Price £384.99**
- 4 300 Gallon (1362 litres)**  
RRP £538.34 **Our Price £469.99**
- 5 400 Gallon (1816 litres)**  
RRP £897.65 **Our Price £769.99**



**Half Price**

### All-in-One Pump Offer

Buy any Instalog Pond and claim PondXpert TripleAction Pump for **£39.99** (usually £79.99)



# Pond Tanks

## PondXpert Round Pond 1000 Ltr

Extra-large round plastic pond that can be used self-standing or partially buried.

**Dimensions:** Diameter 1.4m (4' 7")  
Height 0.9m (3')  
Vol. 1000 Ltrs (220 Galls)

Manufactured out of heavy duty plastic this pond features an elegant 'rolled' top and it's shape tapers down attractively to 1.17m (3' 10").

RRP £799.99  
**Our Price £399.99**

Price includes pallet delivery to mainland UK.



Pond shown against an adult bicycle to help illustrate scale



**More Round Tub Sizes Available Online!**

## PondXpert Round Tub 90 Ltr

Round plastic pond or reservoir that can be self-standing or buried.

**Dimensions:**  
Diameter 67cm (2' 3")  
Height 35cm (1' 2")  
Vol. 90 Ltrs (20 Galls)

RRP £49.99  
**Our Price £24.99**



## PondXpert Round Tub 150 Ltr

**Dimensions:**  
Diameter 88cm  
Height 32cm  
Vol. 150 Ltrs

RRP £129.99  
**Our Price £64.99**

**NEW**



## PondXpert HD Lid 85cm

(fits 150 Ltr Tub)

This heavy duty lid is perfect size for most wooden half-barrels.

RRP £159.99  
**Our Price £79.99**

**NEW**



## 150 Ltr Tub + Lid Set

Usual Price £144.98  
**Our Price £119.99**

## PondXpert Round Tub 90 Ltr Lid

Heavy-duty lid for use with 90 Ltr tub.  
Diameter 67cm (2' 3").

RRP £79.99  
**Our Price £39.99**



## PondXpert Round Tub 90 Ltr & Lid Set DEAL

**Our Price £54.99**  
**Save £9.99**

**Super Value (lightweight) Sump+ Lid Kit**  
Add a Pebble Pond Kit (pg 16) to a 90 Ltr Tub  
**90 Ltr + Standard round PPK £39.99** (save £5)  
**90 Ltr + Heavy Duty PPK £54.99** (save £10)

Pump sits inside pebble pond 'bowl' suspended above the round 90ltr tank (need to perforate bowl).

Easier to reach pump without getting sleeves wet  
Bigger reservoir means less 'topping up' of water

## PondXpert Round Tub 275 Ltr

**Dimensions:**  
Dia. 1.12m (3' 8")  
Height 0.33m (1' 1")  
Vol 275 Ltrs (61 gallons)

RRP £259.99  
**Our Price £129.99**

**NEW**





# Pond Tanks

## 1 Small Tank

105 x 72 x 30cm 3' 6" x 2' x 1"  
Pond Volume 227 litres, (50 gall).

**Our Price £99.99**



Tanks on this page are super-strong and can be positioned above ground if required. Opportunity exists to wrap a non-load bearing frame around pond as shown below.

## 2 Medium Tank

130 x 80 x 46cm 4' 3" x 2' 7" x 1' 6"  
Pond Volume 410 litres, (90 gall).

**Our Price £199.99**



## 3 Large Tank

180 x 120 x 60cm (6' x 4' x 2')  
Pond Volume 1000 Litres.

**Our Price £379.99**



Price includes pallet delivery to mainland UK

## Blagdon Liberty No Dig Nature Pool

**NEW**

*Complete pond kit that allows you to create a 'pop up' thriving ecosystem in your own garden.*

Kit includes everything you need to get started, including a solar floating fountain pump, wood-effect resin panels, fibre reinforced liner and underlay, beach with planting pocket and wildlife ladder.

- Easy to build - Click fit in under an hour
- Includes bird bathing beach & wildlife Ladder
- 3 year guarantee
- Includes solar floating fountain (see pg 38)

Dimensions: 95 x 95 x 36cm (LWH)  
Capacity: 190 Litres (42 Gallons)

**Pump info pg 38**

RRP £224.99

**Our Price £199.99**



## Raised Ponds

*Transform your garden in 30 minutes*

**SUMMER SALE**

**HOZELOCK CYPRIO**



\* Artist's illustration

## Hozelock Outdoor Aquarium

Simple & easy installation within 30 minutes by one person. Simple 'Twist & Lock' system means no tools are required.

95 x 95 x 70cm LWH (3'1" x 3'1" x 2'4")

25% larger capacity compared to medium sized Blagdon Affinity ponds.

3 Year Guarantee.

- Contemporary raised pond design.
- Ideal for smaller gardens.
- No Digging.
- Safe for small children.
- Our exclusive special offer sets provide a complete pond set-up at a great low price.

## Hozelock Outdoor Aquarium

RRP £414.99 Was £299.99 **Sale Price £279.99**

**- Special Offer -**

**Hozelock Outdoor Aquarium + PondXpert TripleAction 2000**

**£319.99 Save £39.99**

# Pebble Pond Kits

## PondXpert Pebble Pond Kits

Include reservoir and lid.



### 1 Standard Round £19.99

63cm diameter x 20cm depth Max volume: 16 Litres. max Load 25kg  
Note: One typical bag of white cobbles weights 25kg

### 2 Heavy Duty Round £39.99

65cm diameter x 28cm depth Max volume: 16 Litres. max Load 50kg

### 3 Standard Square £69.99

80cm diameter x 30cm depth Max volume: 30 Litres. max Load 25kg



## Solar Pebble Pond Kits

Just add pebbles and water! (not included)

### Solar Pebble Kit 250 - Direct Only

Kit includes the following items:

- PondXpert Standard Round Kit
- PondXpert SunnyPump 250 (see pg 38)

**Our Price £39.99** you save **£9.99\***

### Solar Pebble Kit 200 - Battery

Kit includes the following items:

- PondXpert Standard Round Kit
- PondXpert SolarShower 200 Pump (see pg 41)

**Our Price £69.99** you save **£9.99\***

\* Saving compared to buying items separately



## Pebble Ponds *Luxury DIY Pebble Kit*



### Round Feature Basin

66cm x 31cm (22") diameter tank holds 68 litres of water.

RRP £22.89 **Our Price £19.99**



### Heavy Duty Lid

66cm (22") diameter grill fits securely onto the top of the Round Basin via fixing stumps.

RRP £79.99 **Our Price £39.99**



### Round Basin & Lid Deal

Create a self-contained water feature with this heavy duty grid & 68ltr reservoir.

**Combo Deal Price £59.98 £49.99**

Save **£9.99\***

\*on buying individually

# Pond Fun Features

## PondXpert ViewTube Fish Towers

Watch in wonder as your fish magically appear and swim above your pond surface.

Made out of clear acrylic the Tower stands 65cm high (40cm tube + 30cm stand) with a diameter of 20cm

Fish will be attracted by warmer water inside tube or food can be added as an incentive.

Designed for small/medium fish. Not suitable for mature koi.

RRP £139.99 Was £69.99 **Sale Price £49.99**

### Installation Notes

Metal stand must be placed on a stable flat surface. You will need to get into your pond and completely submerge the tower underwater before using a 'tilt and lift' motion to position it on its stand with base of tower still under the water.

Alternatively if you have a pond vacuum this can be used to suck the air out of the dome and it will automatically fill with water.



## PondXpert ViewTube Large

**Wider tower allows big fish to enjoy the view!**

50% larger diameter column (30cm vs 20cm).

RRP £199.99 Was £99.99 **Sale Price £79.99**



## Velda Koi Dome

3D 'fish viewer' that floats on the surface of your pond.

**Medium 35cm Dome RRP £89.99 Our Price £79.99**



# SUMMER SALE

# ShedShield EPDM

## Shed Roof Kits

PondKeeper has been a rubber sheet specialist for nearly 20 years. Now we are offering you the chance to waterproof your garden buildings as well as your pond!

As a volume buyer of rubber lining we are able to buy in bulk direct from the factory. This enables us to pass onto you highly competitive Roof Kit deals.

### Perfect For

- Sheds & Summerhouses
- Office Rooms & Cabins
- Play houses & storage



**NEW**



\* Savings based against post-promotion pricing

### Each Kit includes:

- Rubber EPDM single sheet 0.8mm
- EPDM Mastic 310ml
- Water Based Deck Adhesive 2.5L
- Roller applicator
- Installation instructions

Each EPDM Sheet includes 30cm of spare material on the length and width and can be easily trimmed to final size with scissors.

Note: Rubber roofing sheets include factory welded seams universally typical of the vulcanising process.

Shed Size Imperial	Shed Size Metric	EPDM Liner Size	Standard Price	OFFER PRICE	You Save
6 x 4ft	1.83 x 1.22	2.1 x 1.7m	£63.60	<b>£53.00</b>	<b>£10.60</b>
7 x 5ft	2.13 x 1.52	2.5 x 2.0m	£80.40	<b>£67.00</b>	<b>£13.40</b>
8 x 6ft	2.44 x 1.83	3.0 x 2.5m	£106.80	<b>£89.00</b>	<b>£17.80</b>
10 x 6ft	3.05 x 1.83	3.5 x 2.5m	£118.80	<b>£99.00</b>	<b>£19.80</b>
10 x 8ft	3.05 x 2.44	3.5 x 3.0m	£137.99	<b>£115.00</b>	<b>£22.99</b>
12 x 10ft	3.66 x 3.05	4.0 x 3.5m	£172.80	<b>£144.00</b>	<b>£28.80</b>
14 x 8ft	4.27 x 2.44	5.0 x 3.0m	£187.20	<b>£156.00</b>	<b>£31.20</b>

## EPDM rubber is a superior roofing material compared to shed felt

### Bitumen Roofing Felt

Affordable roofing supplied with many outbuildings in the UK. Joined on-site. Low-cost benefits are unfortunately outweighed by lower performance and higher maintenance levels. Felt is not UV protected so will degrade quite quickly. Around 5 years lifespan is typical.

### EPDM Waterproofing Membrane

Supplied as a single sheet.  
Guaranteed for 20 years - 50 year+ expectancy  
UV Stable  
Maintenance free  
Tear resistant.



# PondKeeper Pond Liner Build Project

We built our pond using an EasyPond 30,000 Complete Kit. We then finished the pond with PondXpert Stone Liner and underwater lights.



**1** For a big pond like ours we recommend hiring a mini excavator. Hire by the day or weekend - great fun!



**2** Finishing the dig by hand - digging out shelves and smoothing the surface. Get rid of as many stones as you can.



**3** Due to the very stony nature of the ground we chose to upgrade to Fleece Underlay (Dog optional!)



**4** Once the liner has been unfolded it's time to smooth it into the shelves and corners as best you can (barefoot is best).



**5** Fill pond with water. We filled ours straight from the mains via a hosepipe.



**6** Weigh liner edges down then smooth away folds as water starts to fill the pond.

# Pond Liners

All ponds start by digging a hole in the earth and then lining it before filling with water. A liner is essential as it creates a watertight barrier to stop the water seeping back into the earth.

We are a pond liner specialist and we want to guide you into making the correct choice.

Our 'ready reckoner' in the first column of our liner listings (overleaf) shows the resulting pond that can be created by the many pre-cut sizes we have in stock.

With flexible liners the choice of pond shape and depth are up to you. If keeping fish we recommend at least part of the pond to be 1m deep for fish to overwinter.

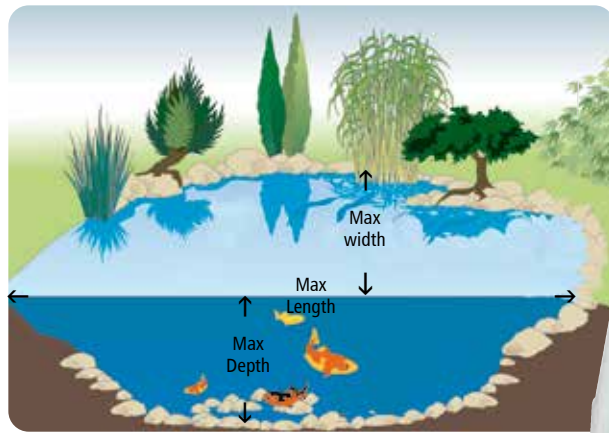

## Calculating your liner size

**Length =**  
max. pond length + (depth x 2) + 1m overlap

**Width =**  
max. pond width + (depth x 2) + 1m overlap

## PondXpert EPDM Bonding Mastic 310ml

Use to bond rubber liners.

**Our Price £14.99**  
**Cartridge Gun £7.99**  
**Mastic + Gun Set £19.99**



1070 independent customer reviews for our liners 99% Average Satisfaction Rating. It's not only our liners that are watertight!

## Quality Guarantee

### Firestone Rubber 1.02mm Only £12.85 per sqm (£1.19 sq foot)

This EPDM geomembrane is the thickest liner we sell (1mm). New to our range, selected to compete with Butyl that is unfortunately rocketing in price.

It is straightforward to seam or repair and is guaranteed for 20 years. Uniquely this liner sizes is measured off in imperial measurements (feet).



**Half Price Fleece Underlay with all Firestone Liners**

L x W Metres	L x W Feet	OUR PRICE
3.1 x 2.4	10 x 8	£95.63
3.1 x 3.1	10 x 10	£119.54
3.7 x 3.1	12 x 10	£143.44
4.0 x 3.1	13 x 10	£155.20
4.9 x 4.3	16 x 14	£267.76
5.5 x 4.3	18 x 14	£301.23
6.1 x 4.9	20 x 16	£382.52
6.1 x 5.5	20 x 18	£430.33
6.7 x 6.1	22 x 20	£525.96
7.9 x 6.1	26 x 20	£620.81
9.1 x 7.9	30 x 26	£930.20
12.2 x 8.5	40 x 28	£1,336.15
12.2 x 9.2	40 x 30	£1,433.27
30.5 x 15.2	100 x 50	£5,969.00

Over 60 more sizes exist online - We can supply any of the listed widths in maximum lengths of 100' (30.5m)

# Pond Liners

All successful pond projects start with a good waterproof pond liner. A pond liner provides a watertight membrane to stop pond water seeping away.

## PVC Pond Liner

We have extended our range of 0.5mm and 0.3mm PVC liners this year. Thicker than LDPE but not tearproof. These are priced:

15yr guarantee Only **£4.49** per sqm (£0.42 sq foot)  
30yr guarantee Only **£4.89** per sqm (£0.45 sq foot)

## Half Price Underlay with 30yr PVC

### Butyl rubber

First choice for professionals for many years. Lifetime guarantee (20yrs on 140sqm plus), 0.75mm thick.

Only **£12.49** per sqm (£1.16 sq foot)



**Half Price Fleece Underlay**

### EPDM rubber

Same physical characteristics as Butyl but with significant cost savings. Lifetime guarantee (20yrs on 140sqm plus), 0.75mm thick. We find that this synthetic rubber now outsells butyl.

Only **£9.49** per sqm (£0.88 sq foot)

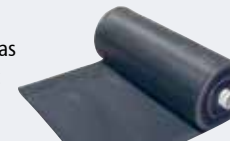

**Half Price Fleece Underlay**

### Flexiliner LDPE

Our bestselling liner. Double-laminated with a reinforced core. Durable, tearproof yet light to work with. The perfect Garden pond liner.

**Half-Price Underlay Offer Over 100 pre-cut sizes - See overleaf**

From only **£1.99** per sqm (£0.18 sq foot)



**Bestseller**

# Underlay

We recommend that all pond liners are underlaid as extra protection for your liner. It helps to prevent root penetration and punctures from small stones/debris. Underlay supplied matches the sqm of our liners.

"Basic" is a budget underlay, providing a good level of protection. Particularly suitable for small ponds or where sand is used as a primary barrier.

Only **£1.80** per sqm (£0.17 sq foot)

"Pond Fleece" premium underlay is a heavy 200gsm needled felt. Recommended for all ponds - particularly larger liners or stoney ground.

Only **£2.80** per sqm (£0.26 sq foot)

## Glue & Repair Tape/Kits

**Heissner easyFIX Tape** Waterproof tape. Available in black or clear colour. 10cm wide x 150cm length.

**easyFIX Black Our Price £19.99**  
**easyFIX Clear Our Price £19.99**



**Cold Glue** double-sided tape can be used on all liners\* - use it to join liners together or to fix punctures or tears. 5cm wide (2inch) 2mm thick.

**£5.00 per linear mtr.**  
**£34.99 for 10m roll**



\* Excluding PVC

**Velda VT PVC Patch Kit** High performance underwater adhesive with PVC liner piece (40x20cm). Works with all PVC liners.

RRP £17.99 **£14.49**

## PondXpert Pond Liner Repair Kits

A4 sized Flexiliner & 1m Cold Glue **£5.99**  
A4 sized EPDM Liner & 1m Cold Glue **£8.99**  
A4 Sized Butyl Liner & 1m Cold Glue **£9.99**  
50x50cm Flexiliner & 3m Cold Glue **£19.99**  
50x50cm EPDM & 3m Cold Glue **£24.99**  
50x50cm Butyl & 3m Cold Glue **£29.99**  
1x1m Flexiliner & 10m Cold Glue **£39.99**  
1x1m EPDM Liner & 10m Cold Glue **£49.99**  
1x1m Butyl Liner & 10m Cold Glue **£59.99**



Max Pond Size (LxWxD)	Liner Size Metres	Flexiliner - LDPE				Rubber Liners		Underlay Choice		BEST DEAL ½ PRICE FLEECE + 40Yr LINER
		15yr	25yr	40yr	PVC 15yr	EPDM	Butyl	Fleece	Basic	
0.4x0.4x0.3	2 x 2	£7.96	£9.96	£11.96	-	£37.96	£49.96	£11.20	£7.20	£17.56
0.9x0.4x0.3	2.5 x 2	£9.95	£12.45	£14.95	-	£47.45	£62.45	£14.00	£9.00	£21.95
0.9x0.9x0.3	2.5 x 2.5	£12.44	£15.56	£18.69	-	£59.31	£78.06	£17.50	£11.25	£27.44
1.4x0.4x0.3	3 x 2	£11.94	£14.94	£17.94	£26.94	£56.94	£74.94	£16.80	£10.80	£26.34
1.4x0.9x0.3	3 x 2.5	£14.93	£18.68	£22.43	-	£71.18	£93.68	£21.00	£13.50	£32.93
1 x 1 x 0.5	3 x 3	£17.91	£22.41	£26.91	£40.41	£85.41	£112.41	£25.20	£16.20	£39.51
1.5 x 1 x 0.5	3.5 x 3	£20.90	£26.15	£31.40	-	£99.64	£131.15	£29.40	£18.90	£46.10
2 x 1 x 0.5	4 x 3	£23.88	£29.88	£35.88	£53.88	£113.88	£149.88	£33.60	£21.60	£52.68
2 x 1.5 x 0.5	4 x 3.5	£27.86	£34.86	£41.86	-	£132.86	£174.86	£39.20	£25.20	£61.46
2 x 2 x 0.5	4 x 4	£31.84	£39.84	£47.84	£71.84	£151.84	£199.84	£44.80	£28.80	£70.24
2.5 x 2 x 0.5	4.5 x 4	£35.82	£44.82	£53.82	-	£170.82	£224.82	£50.40	£32.40	£79.02
3 x 1 x 0.5	5 x 3	£29.85	£37.35	£44.85	-	£142.35	£187.35	£42.00	£27.00	£65.85
2 x 1 x 1	5 x 4	£39.80	£49.80	£59.80	£89.80	£189.80	£249.80	£56.00	£36.00	£87.80
2 x 1.5 x 1	5 x 4.5	£44.78	£56.03	£67.28	-	£213.15	£281.03	£63.00	£40.50	£98.78
2 x 2 x 1	5 x 5	£49.75	£62.25	£74.75	£112.25	£237.25	£312.25	£70.00	£45.00	£109.75
2 x 2.5 x 1	5.5 x 5	£54.73	£68.48	£82.23	-	£260.98	£343.48	£77.00	£49.50	£120.73
4 x 1 x 0.5	6 x 3	£35.82	£44.82	£53.82	£80.82	£170.82	£224.82	£50.40	£32.40	£79.02
3 x 1 x 1	6 x 4	£47.76	£59.76	£71.76	£107.76	£227.76	£299.76	£67.20	£43.20	£105.36
3 x 1.5 x 1	6 x 4.5	£53.73	£67.23	£80.73	-	£256.23	£337.23	£75.60	£48.60	£118.53
3 x 2 x 1	6 x 5	£59.70	£74.70	£89.70	£134.70	£284.70	£374.70	£84.00	£54.00	£131.70
3 x 2.5 x 1	6 x 5.5	£65.67	£82.17	£98.67	-	£313.17	£412.17	£92.40	£59.40	£144.87
3 x 3 x 1	6 x 6	£71.64	£89.64	£107.64	£161.64	£341.64	£449.64	£100.80	£64.80	£158.04
3 x 3.5 x 1	6.5 x 6	£77.61	£97.11	£116.61	-	£370.11	£487.11	£109.20	£70.20	£171.21
5 x 1 x 0.5	7 x 3	£41.79	£52.29	£62.79	-	£199.29	£262.29	£58.80	£37.80	£92.19
4 x 1 x 1	7 x 4	£55.72	£69.72	£83.72	-	£265.72	£349.72	£78.40	£50.40	£122.92
4 x 2 x 1	7 x 5	£69.65	£87.15	£104.65	£157.15	£332.15	£437.15	£98.00	£63.00	£153.65
4 x 2.5 x 1	7 x 5.5	£76.62	£95.87	£115.12	-	£365.37	£480.87	£107.80	£69.30	£169.02
4 x 3 x 1	7 x 6	£83.58	£104.58	£125.58	£188.58	£398.58	£524.58	£117.60	£75.60	£184.38
4 x 3.5 x 1	7 x 6.5	£90.55	£113.30	£136.05	-	£431.80	£568.30	£127.40	£81.90	£199.75
4 x 4 x 1	7 x 7	£97.51	£122.01	£146.51	-	£465.01	£612.01	£137.20	£88.20	£215.11
4.5 x 3 x 1	7.5 x 6	£89.55	£112.05	£134.55	-	£427.05	£562.05	£126.00	£81.00	£197.55
4.5 x 4 x 1	7.5 x 7	£104.48	£130.73	£156.98	-	£498.23	£655.73	£147.00	£94.50	£230.48
4.5 x 4.5 x 1	7.5 x 7.5	£111.94	£140.06	£168.19	-	£533.81	£702.56	£157.50	£101.25	£246.94
6 x 1 x 0.5	8 x 3	£47.76	£59.76	£71.76	-	£227.76	£299.76	£67.20	£43.20	£105.36
5 x 1 x 1	8 x 4	£63.68	£79.68	£95.68	-	£303.68	£399.68	£89.60	£57.60	£140.48
5 x 2 x 1	8 x 5	£79.60	£99.60	£119.60	-	£379.60	£499.60	£112.00	£72.00	£175.60
5 x 3 x 1	8 x 6	£95.52	£119.52	£143.52	£215.52	£455.52	£599.52	£134.40	£86.40	£210.72
5 x 4 x 1	8 x 7	£111.44	£139.44	£167.44	£251.44	£531.44	£699.44	£156.80	£100.80	£245.84
5 x 5 x 1	8 x 8	£127.36	£159.36	£191.36	£287.36	£607.36	£799.36	£179.20	£115.20	£280.96
6 x 2 x 1	9 x 5	£89.55	£112.05	£134.55	-	£427.05	£562.05	£126.00	£81.00	£197.55
6 x 3 x 1	9 x 6	£107.46	£134.46	£161.46	£242.46	£512.46	£674.46	£151.20	£97.20	£237.06
6 x 4 x 1	9 x 7	£125.37	£156.87	£188.37	£282.87	£597.87	£786.87	£176.40	£113.40	£276.57
6 x 5 x 1	9 x 8	£143.28	£179.28	£215.28	£323.28	£683.28	£899.28	£201.60	£129.60	£316.08
6 x 6 x 1	9 x 9	£161.19	£201.69	£242.19	-	£768.69	£1,011.69	£226.80	£145.80	£355.59
7 x 2 x 1	10 x 5	£99.50	£124.50	£149.50	-	£474.50	£624.50	£140.00	£90.00	£219.50
7 x 3 x 1	10 x 6	£119.40	£149.40	£179.40	£269.40	£569.40	£749.40	£168.00	£108.00	£263.40
7 x 4 x 1	10 x 7	£139.30	£174.30	£209.30	-	£644.30	£874.30	£196.00	£126.00	£307.30
7 x 5 x 1	10 x 8	£159.20	£199.20	£239.20	£359.20	£759.20	£999.20	£224.00	£144.00	£351.20
7 x 6 x 1	10 x 9	£179.10	£224.10	£269.10	-	£854.10	£1,124.10	£252.00	£162.00	£395.10

Max Pond Size (LxWxD)	Liner Size Metres	Flexiliner - LDPE				Rubber Liners		Underlay Choice		BEST DEAL ½ PRICE FLEECE + 40Yr LINER
		15yr	25yr	40yr	PVC 15yr	EPDM	Butyl	Fleece	Basic	
7 x 7 x 1	10 x 10	£199.00	£249.00	£299.00	-	£949.00	£1,249.00	£280.00	£180.00	£439.00
8 x 4 x 1	11 x 7	£153.23	£191.73	£230.23	-	£730.73	£961.73	£215.60	£138.60	£338.03
8 x 5 x 1	11 x 8	£175.12	£219.12	£263.12	£395.12	£835.12	£1,099.12	£246.40	£158.40	£386.32
8 x 6 x 1	11 x 9	£197.01	£246.51	£296.01	-	£939.51	£1,236.51	£277.20	£178.20	£434.61
8 x 7 x 1	11 x 10	£218.90	£273.90	£328.90	-	£1,043.90	£1,373.90	£308.00	£198.00	£482.90
9 x 4 x 1	12 x 7	£167.16	£209.16	£251.16	-	£797.16	£1,049.16	£235.20	£151.20	£368.76
9 x 5 x 1	12 x 8	£191.04	£239.04	£287.04	£431.04	£911.04	£1,199.04	£268.80	£172.80	£421.44
9 x 6 x 1	12 x 9	£214.92	£268.92	£322.92	-	£1,024.92	£1,348.92	£302.40	£194.40	£474.12
9 x 7 x 1	12 x 10	£238.80	£298.80	£358.80	-	£1,138.80	£1,498.80	£336.00	£216.00	£526.80
9 x 9 x 1	12 x 12	£286.56	£358.56	£430.56	-	£1,366.56	£1,798.56	£403.20	£259.20	£632.16
10 x 5 x 1	13 x 8	£206.96	£258.96	£310.96	£466.96	£986.96	£1,298.96	£291.20	£187.20	£456.56
10 x 6 x 1	13 x 9	£232.83	£291.33	£349.83	-	£1,110.33	£1,461.33	£327.60	£210.60	£513.63
10 x 7 x 1	13 x 10	£258.70	£323.70	£388.70	-	£1,233.70	£1,623.70	£364.00	£234.00	£570.70
10 x 9 x 1	13 x 12	£310.44	£388.44	£466.44	-	£1,480.44	£1,948.44	£436.80	£280.80	£684.84
10 x 10 x 1	13 x 13	£336.31	£420.81	£505.31	-	£1,603.81	£2,110.81	£473.20	£304.20	£741.91
11 x 5 x 1	14 x 8	£222.88	£278.88	£334.88	£502.88	£1,062.88	£1,398.88	£313.60	£201.60	£491.68
11 x 6 x 1	14 x 9	£250.74	£313.74	£376.74	-	£1,195.74	£1,573.74	£352.80	£226.80	£553.14
11 x 7 x 1	14 x 10	£278.60	£348.60	£418.60	-	£1,328.60	£1,748.60	£392.00	£252.00	£614.60
11 x 9 x 1	14 x 12	£334.32	£418.32	£502.32	-	£1,594.32	£2,098.32	£470.40	£302.40	£737.52
11 x 11 x 1	14 x 14	£390.04	£488.04	£586.04	-	£1,860.04	£2,448.04	£548.80	£352.80	£860.44
12 x 5 x 1	15 x 8	£238.80	£298.80	£358.80	£538.80	£1,138.80	£1,498.80	£336.00	£216.00	£526.80
12 x 6 x 1	15 x 9	£268.65	£336.15	£403.65	-	£1,287.15	£1,686.15	£378.00	£243.00	£592.65
12 x 7 x 1	15 x 10	£298.50	£373.50	£448.50	-	£1,423.50	£1,873.50	£420.00	£270.00	£658.50
12 x 9 x 1	15 x 12	£358.20	£448.20	£538.20	-	£1,708.20	£2,248.20	£504.00	£324.00	£790.20
12 x 12 x 1	15 x 15	£447.75	£560.25	£672.75	-	£2,135.25	£2,810.25	£630.00	£405.00	£987.75
13 x 7 x 1	16 x 10	£318.40	£398.40	£478.40	-	£1,518.40	£1,998.40	£448.00	£288.00	£702.40
13 x 9 x 1	16 x 12	£382.08	£478.08	£574.08	-	£1,822.08	£2,398.08	£537.60	£345.60	£842.88
15 x 7 x 1	18 x 10	£358.20	£448.20	£538.20	-	£1,708.20	£2,248.20	£504.00	£324.00	£790.20
15 x 9 x 1	18 x 12	£429.84	£537.84	£645.84	-	£2,049.84	£2,697.84	£604.80	£388.80	£948.24
15 x 12 x 1	18 x 15	£537.30	£672.30	£807.30	-	£2,562.30	£3,372.30	£756.00	£486.00	£1,185.30
17 x 12 x 1	20 x 15	£597.00	£747.00	£897.00	PVC Up	£2,847.00	£3,747.00	£840.00	£540.00	£1,317.00
17 x 15 x 1	20 x 18	£716.40	£896.40	£1,076.40	To 30x25	£3,416.40	£4,496.40	£1,008.00	£648.00	£1,580.40
21 x 12 x 1	24 x 15	£716.40	£896.40	£1,076.40	Available	£3,416.40	£4,496.40	£1,008.00	£648.00	£1,580.40
21 x 15 x 1	24 x 18	£859.68	£1,075.68	£1,291.68	Special	£4,099.68	£5,395.68	£1,209.60	£777.60	£1,896.48
23 x 15 x 1	26 x 18	£931.32	£1,165.32	£1,399.32	Order	£4,441.32	£5,845.32	£1,310.40	£842.40	£2,054.52
23 x 17 x 1	26 x 20	£1,034.80	£1,294.80	£1,554.80	Please	£4,934.80	£6,494.80	£1,456.00	£936.00	£2,282.80
25 x 15 x 1	28 x 18	£1,002.96	£1,254.96	£1,506.96	Ask	£4,782.96	£6,294.96	£1,411.20	£907.20	£2,212.56
25 x 17 x 1	28 x 20	£1,114.40	£1,394.40	£1,674.40		£5,314.40	£6,994.40	£1,568.00	£1,008.00	£2,458.40
27 x 13 x 1	30 x 16	£955.20	£1,195.20	£1,435.20		£4,555.20	£5,995.20	£1,344.00	£864.00	£2,107.20
27 x 15 x 1	30 x 18	£1,074.60	£1,344.60	£1,614.60		£5,124.60	£6,744.60	£1,512.00	£972.00	£2,370.60
27 x 17 x 1	30 x 20	£1,194.00	£1,494.00	£1,794.00		£5,694.00	£7,494.00	£1,680.00	£1,080.00	£2,634.00
29 x 17 x 1	32 x									

# Pond Liner Edging



**Bestseller**



**“Classic”  
Finish**



**“Pebble” or “Stone-Faced” liner protects the exposed parts of the pond liner and makes the transition between pond and land seamless.**

This special material is manufactured in the Netherlands and our unique direct relationship with the producer means we can sell it to you at an exclusive price.

With approximately 225 stone particles per square inch this is the best quality stone liner around.

You can find the same product under other brand names elsewhere at a much higher price. *Grab yourself a bargain!*

**10% Bulk discount on full rolls**

Price per linear metre, cut off roll	Was	NOW	Full Roll	
			Length	PRICE
Stone Liner 0.4m Classic	£11.99	<b>£9.49</b>	25m	<b>£212.99</b>
Stone Liner 0.6m Classic	£16.99	<b>£14.99</b>	20m	<b>£268.99</b>
Stone Liner 1.0m Classic	£29.99	<b>£24.99</b>	12m	<b>£268.99</b>
Stone Liner 1.2m Classic	£39.99	<b>£31.99</b>	12m	<b>£349.99</b>

A mix of grey granite colour & lighter stones



**Terrazzo  
Finish**



**10% Bulk discount on full rolls**

Price per linear metre, cut off roll	Was	NOW	Full Roll	
			Length	PRICE
Stone Liner 0.4m Terrazzo	£11.99	<b>£10.99</b>	25m	<b>£244.99</b>
Stone Liner 0.6m Terrazzo	£16.99	<b>£16.49</b>	20m	<b>£304.99</b>
Stone Liner 1.0m Terrazzo	£29.99	<b>£26.99</b>	12m	<b>£289.99</b>
Stone Liner 1.2m Terrazzo	£39.99	<b>£34.99</b>	12m	<b>£374.99</b>



**Filbert Frog's Top Tip**

This stone liner can be used to create a beach area which is perfect for me and my pondlife buddies. It lets us get in and out of the water as we please.

Also obstructions such as pond hose and electrical cable can be hidden underneath the additional layer of cover - this makes our pool look a whole lot better!

# Water Courses

Our new 'Riverstone' falls have been created to add an instant authentic appeal to your pond. Use individually or join together to create a longer waterfall. Recommended pump flow 1500LPHs.

**River Pebbles** range come in a beautiful 'aged' appearance - off white with a touch of algae green for an ultra realistic effect.

**River Pebbles Stream**  
70 x 54 x 20cm (LWH)



**River Pebbles Drop**  
69 x 61 x 20cm (LWH)



**River Slate** range come in a beautiful 'aged' appearance - grey with a touch of algae green for an ultra realistic effect.

**River Slate Cascade**  
67x 57 x 16cm (LWH)



**River Slate Drop**  
64 x 62 x 20cm (LWH)

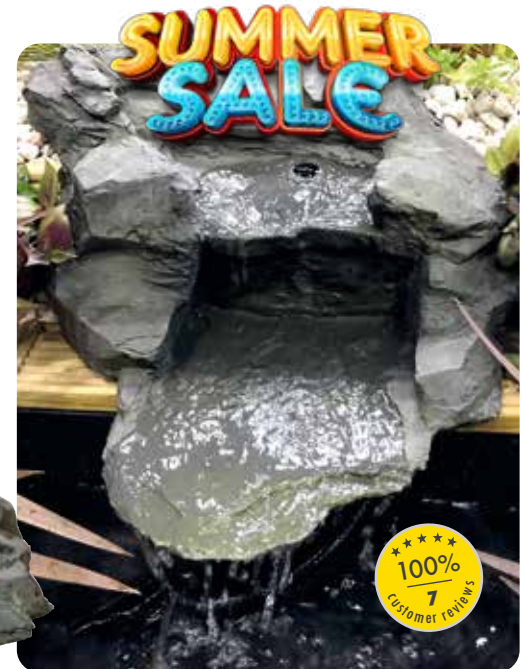

**All Falls on this page** Were £109.99 Sale Price **£99.99**

# Water Courses

Most ponds have a waterfall. They create a real focal point and the bubbling water helps to oxygenate the pond. Also you will find a natural bank of earth is created by the displaced soil after your pond dig. The following pages show the best preformed watercourses on the market today.

## Sandstone Series

are made out of tough fibreglass but the surfaces are hand finished to resemble real stone. These falls can be used individually or joined together to create a longer stream.

(Dimensions cm W x L x Pour)



**1 Curved Stream**  
70x107x30cm  
RRP £264.99  
**Our Price £219.99**



**2 Tiered Casacde**  
55x71x38cm  
RRP £186.99  
**Our Price £149.99**



**3 Cascade/header**  
69x68x17cm  
RRP £186.99  
**Our Price £149.99**



**Bestseller**



**4 Large Fall**  
73x123x18cm  
RRP £372.99  
**Our Price £299.99**



★★★★★  
100%  
3  
Customer Reviews

**SUMMER SALE**

Single Step Watercourse



★★★★★  
100%  
11  
Customer Reviews

**Bestseller**

Double Step Watercourse

**Sandy Super Sellers** Medium sized falls with discreet water entry area fed by built-in 20-40mm hoesetail - can be combined if required.

**5 Single Step** 55x71x38 RRP £124.99  
Was £99.99 **Price £89.99**

**6 Double Step** 55x90x38 RRP £165.99  
Was £129.99 **Price £119.99**



### Fibert Frog's Top Tip

Genuine stone waterfalls look great but are incredibly difficult and heavy to work with. These realistic falls look the part and are far easier to install.

# Water Courses

## Rockways Rustic Slate Watercourse

This is the finest watercourse we have seen. Supplied in a rustic slate finish it looks incredibly realistic and would grace any water garden.

The course is modular so it can be run as a three piece structure (as shown) or changed to a two or four piece structure.

The top piece includes a 25-40mm hose inlet so the water feed can be disguised.

Overlapping 3 shelf feature as shown is approximately 1.7m x 1m x 0.8m LxWxH

Recommended flow rate 2400lph

**1 Top** - Shelf with inlet 70x105x15cm  
RRP £196.99 **Our Price £169.99**

**2 Middle** - Shelf 70x105x15cm  
RRP £196.99 **Our Price £169.99**

**3 Bottom** - Shelf Overhang 83x109x12cm  
RRP £196.99 **Our Price £169.99**

**Complete 3-piece fall**  
RRP £510.99 **Our Price £399.99**

**4 Single Mould Fall**



Mix and match Options 'Top' with 'Overhang'



### Fibert Frog's Top Tip

Middle shelves can be added to increase the height and length if required.

★★★★★  
100%  
1  
Customer Reviews

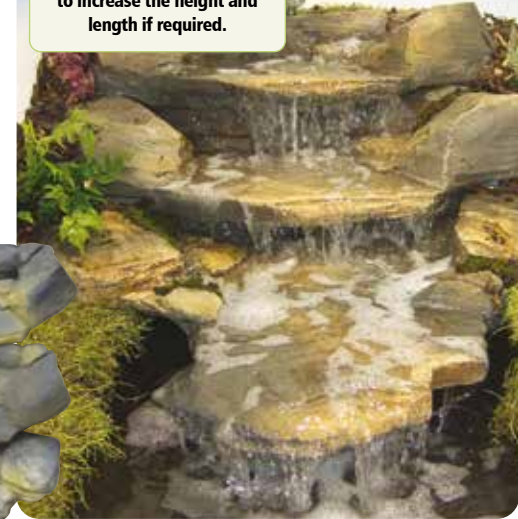

'Separates' Combo Deal ie, 'Top' plus 'Middle' plus 'Overhang'  
RRP £590.99 **Our Price £449.99 Save 59.98**

**1 Top with Inlet**



**2 Middle Shelf**



**3 Base Overhang**



# Water Courses

## 1 Slate Fast Falls

Narrow channel creates a fastflowing rapid. Rec. Flow 2000lph.

Dimensions: 104 x 70 x 29 cm (LWH). Available in Rustic Slate or Grey Slate finish  
RRP £280.99 **Our Price £229.99**



## 2 PondXpert Waterfall

Create a winding watercourse into your pond with this attractive waterfall. Over two feet in length this durable, black plastic fall will last for 20 years (guaranteed).

RRP £39.99 **Our Price £24.99**



2



1

Across range

### Black Waterfall Foam

Holds rocks together and directs water where you want it to go!

- Fills gaps and voids
- Black colour blends into shadows
- Doesn't discolour

500ml Can **£19.99**  
750ml Gun Grade Can **£24.99**  
Metal Foam Gun **£29.99**  
Cleaner for Gun & Foam **£9.99**

Gun, 24oz Can and Cleaner Set **£54.97**  
**Save £10.00**



### PondXpert FoamFixer

500ml  
Black waterfall landscaping foam.  
**£17.99**

### FoamFixer Cleaner

**£12.99**  
**Fixer & Cleaner Set**  
**£25.99 Save £5**

# Concrete Pond Accessories

## G4 Clear

	RRP	Our Price
1Kg	£32.59	<b>£29.99</b>
2.5Kg	£64.59	<b>£59.99</b>
5Kg	£102.99	<b>£99.99</b>
25Kg	£427.99	<b>£399.99</b>



## G4 Black

1Kg	£44.99	<b>£39.99</b>
2.5Kg	£95.49	<b>£89.99</b>
5Kg	£172.89	<b>£169.99</b>
25Kg	£718.99	<b>£699.99</b>

## Rein Fibre 1kg

6mm strands for reinforcing mortar. Avoids cracking Apply 20g per 1kg of mortar mix.

**Our Price**  
**£29.99**



## Just Fix It

Two part putty repairs cracks & holes in concrete.

RRP £8.25 **Our Price £7.99**



# All in one Pumps

**EasyClear** - The Complete Clear & Healthy Pond Solution.

Multi-function, compact pond technology solutions specially designed for smaller ponds. The traditional pond system includes a pump, UVC and external filter as separate but intertwined units. The thinking behind these new products is to combine all three of these essential items in one compact, submerged unit.

The benefits of this idea are:

- Easy no-fuss installation
- Completely hidden under the water surface - no conspicuous filter boxes, hoses or multiple electrical cable
- Just connect item to electrics, place underwater, switch on... and that's it!

## Specification

Model	UVC	Max Flow	Max Pond	Recommended Uses
3000	5W	1260 LPH	3000 Ltrs	Fountain only
4500	7W	1260 LPH	4500 Ltrs	Fountain only
6000	9W	1700 LPH	6000 Ltrs	Fountain & waterfall
7500	11W	1700 LPH	7500 Ltrs	Fountain & waterfall
9000	13W	2850 LPH	9000 Ltrs	Fountain & waterfall

25mm inlet/outlet, 10m power cable & 3 fountain head displays

**Bestseller**



ONLINE VIDEO

# SUMMER SALE

**Save £20**

### Customer Notice:

EasyClear 4500 & 7500 models being delisted by manufacturer - Limited Stock Available\*

Description	RRP	WAS	Sale Price
EasyClear 3000	£249.99	£129.99	<b>£109.99</b>
EasyClear 4500	£279.99	£149.99	<b>£129.99</b>

Description	RRP	WAS	Sale Price
EasyClear 6000	£299.99	£169.99	<b>£149.99</b>
EasyClear 7500	£329.99	£179.99	<b>£159.99</b>

Description	RRP	WAS	Sale Price
EasyClear 9000	£369.99	£189.99	<b>£169.99</b>

## Free Gifts

**EasyClear Offer**  
**Free 5m x 25mm Hose & Clips**  
**Free Replacement UV Bulb**  
**worth up to £38.97**





# All in one Pumps

## Blagdon Inpond All-in-One

The Inpond from Blagdon has the added benefit of an integrated LED spotlight to illuminate your fountain. All models come supplied with a large mechanical and biological filtration area. New extended 4-model range for 2016. The new 2000 model has a smaller filtration area and fixed-angle light.



Model	Max Fish Pond Ltrs	UVC Watts	Max Flow	RRP	OUR PRICE
InPond 5in1 2000	2000	5	650	£158.99	£129.99
InPond 5in1 3000	3000	5	700	£182.99	£149.99
InPond 5in1 6000	6000	9	1500	£227.49	£185.99
InPond 6in1 9000	9000	9	3000	£275.49	£227.99



## PondXpert TripleAction 15000 XL

At last the perfect All-in-One Pump designed for bigger ponds!



This new pump from the bestselling TripleAction series boasts a powerful 5200lph pump and super-large filtration chamber. Perfect for creating large fountains and/or waterfalls and keeping water crystal clear. The powerful flow can be adjusted by an integrated flow controller.

- 13 watt UVC
- 55 watts power
- 20/25mm outlets
- Flow adjuster



RRP £359.99  
Was £179.99

**Sale Price**  
**£149.99**

**Note:** Taller dimensions of this pump to accommodate extra filter media. Designed for ponds at least 26cm (10") deep.



### Modular Cartridge Feature

Your TripleAction comes complete with all filtration media. But uniquely, as well as replacement foams, entire additional filtration Cartridges can be purchased.

These cartridges simply click onto your existing pump creating greater filtration capacity and reduced maintenance.

RRP £69.99

**Our Price**  
**£34.99**



Pump with additional Cartridge in position.

# All in one Pumps

## PondXpert TripleAction - NEW Generation

TripleAction series from PondXpert goes straight to the top of our 'best buy' table.

This re-engineered range of all-in-one pumps offer a perfect submerged filtration system solution.

### Features:

- Integrated UVC
- Solution for ponds 2000-9000 litres
- Easy Access Filter Bed
- Adjustable Flow Control via T-piece (12/20/25mm)
- Mixed filter media: Large foam filter plus 2 x zeolite and 1 x neutral biomedica chambers.



Model	Max Pond Ltrs	Max Fish Pond Ltrs	UVC Watts	Max Flow	Usual Price	SALE PRICE
Triple Action 2000	2000	1000	5	1000	£79.99	£69.99
Triple Action 3000	3000	1500	9	1000	£99.99	£79.99
Triple Action 6000	6000	3000	11	2000	£119.99	£99.99
Triple Action 9000	9000	4500	13	2500	£139.99	£119.99
Triple Action 15000XL	15000	7500	13	5200	£179.99	£149.99

**Buy with confidence Now 2 Year Guarantee on all TripleActions**



### PondXpert LED Fountain Light Ring

Submersible light designed to fit TripleAction pumps but 25mm diameter fitting will clip onto most branded fountain pumps. Can be used to attach onto 25mm pond hose to create interesting lighting effects.

- 12 LED Bulbs
- Low voltage weatherproof transformer
- 5m lv cable + 2m mains cable



**LED Light Ring White** RRP £59.99 **Our Price £29.99**

**LED Light Ring Colour** RRP £69.99 **Our Price £34.99**

LED Light Ring fits TripleAction models 2000-9000



**TripleActions** all come with a choice of fountain heads plus a sturdy T-piece and hosetail to direct water to a waterfall or water feature. Enjoy the ability to run a fountain display and/or waterfall across all models.



Biomedica 'Pods'

Foam filtration Media



# Feature Pumps

## PondXpert FeatureFlow Pumps

Comprehensive range of water feature pumps.

- Top value
- 1 year guarantee
- Flow Adjuster
- Choice of power cable length option. Choose 5m (16') or 10m (33')



These pumps pack a punch despite their compact size and are perfect for if you are looking to construct your own water feature - or as a replacement for an existing feature.



Model	Watts	Max Flow	Max Head	Hose Size (mm)	5m Cable	10m Cable
					OUR PRICE	OUR PRICE
FeatureFlow 350	6	350	0.7m	8-12	£14.99	£21.99
FeatureFlow 450	5	450	0.95m	8-12	£16.49	£23.99
FeatureFlow 750	10	700	1.4m	8-12	£19.99	£27.49
FeatureFlow 1000	14	950	1.8m	8-12	£21.99	£29.99
FeatureFlow 1200	20	1200	2.0m	12-20	£24.99	£32.99
FeatureFlow 1500	25	1500	2.5m	12-20	£31.99	£38.99
FeatureFlow 2000	45	2000	3.0m	12-20	£37.99	£44.99
FeatureFlow 3000	70	3000	3.5m	12-25	£59.99	£64.99
FeatureFlow 4000	99	4000	4.0m	12-25	£79.99	£84.99



## Blagdon Auto-Off Feature Pump

This pump offers a unique benefit - it automatically switches off if the water runs low then switches itself back on once water returns.

- 3 year guarantee
- 10m power cable

Model	Watts	Hose	RRP	OUR PRICE
AutoOff 650	10	10-12	£56.49	£46.99
AutoOff 1200	10	10-12	£72.49	£58.99
AutoOff 2000	10	12-25	£106.99	£86.99

## Blagdon MiniPond Feature Pumps

The perfect pump for water features. Low cost indoor version has 3m of power cable - standard outdoor model has 10m.

- 7 watts output.
- 1.0m (3' 3") Max pumping height.
- Max Flow 550lph
- 1 year guarantee.
- Takes hose 12-20mm (1/2"-3/4")

550i RRP £33.49 **Our Price £27.49**  
 550 RRP £42.49 **Our Price £37.99**



# Fountain Pumps

For many an attractive fountain has come to symbolise all that is good about the perfect water garden. From the aesthetically pleasing view of an ever-changing water display to the relaxing patter of falling droplets.

A fountain pumps offers you all of this and more! Your pond and it's inhabitants will thank you too as the moving water helps to aerate the pond by increasing oxygen levels. Most fountains can do more than one job. For instance part of the water flow can be diverted to create a stream or waterfall.

They can even be used to power a filtration system - especially the 'hybrid' fountain pumps which can handle solids. Consider the fountain pump to be the star on top of the christmas tree.

*Your pond is not complete without one . . .*



## PondXpert Fountainsia Pumps

Comprehensive range of fountain pumps offering top features and best value for money.

- Dual Flow Control via sturdy 'T' Piece.
- 1 year guarantee.
- 10m power cable (33 feet).



Model	Display	Watts	Max Flow	Max Head	Hose Size	RRP	OUR PRICE
Fountainsia 1000	A,B	14	1000	1.8m	12-20	£85.99	£42.99
Fountainsia 1500	A,B	25	1500	2.5m	12-20	£109.99	£54.99
Fountainsia 2000	A,B	35	2000	2.5m	12-20	£129.99	£64.99
Fountainsia 3000	A,B,C	60	3000	2.8m	12-25	£149.99	£74.99
Fountainsia 4000	A,B,C	70	4000	2.9m	20-32	£169.99	£84.99

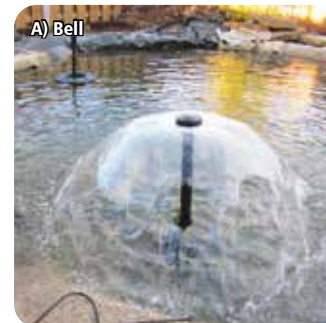

# Fountain Pumps



## Fishmate Pump

### Bestselling most economical fountains

Largest models (16/22000) can handle 12mm solids. Medium models (2400-9000) can be easily modified to take solids up to 5mm. Small pumps 700-1800 are not supplied with a T-piece and are for fountains only.

Model	Fountain Heads	Hose Size	RRP	OUR PRICE
Fishmate 700	A,B,C,D	12	£43.60	£34.99
Fishmate 1200	A,B,C,D	12-25	£55.10	£44.99
Fishmate 2000	A,B,C,D	12-25	£86.40	£69.99
Fishmate 3000	A,B,C,D	12-32	£102.85	£79.99
Fishmate 4000	A,B,C,D	12-32	£119.35	£89.99
Fishmate 5000	A,B,C,D	12-32	£189.30	£169.99
Fishmate 9000	A,B,C,D	12-32	£238.70	£199.99

"This model was one of the easiest to assemble & one of the least prone to blocking"

Which? magazine July 2010 - where Fishmate 3000 scored best in test.

3yr Guarantee

### FISH MATE

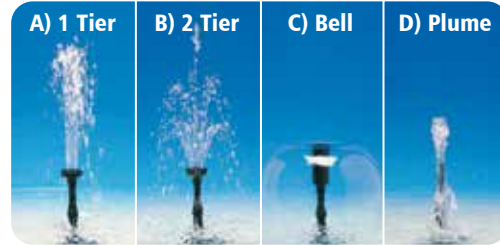

## Cascade Pump

The Cascade falls under the well-known Hozelock brand. Like all of this group's water gardening products it offers a high level of quality at a competitive price.

The cascade pump is an ideal all purpose pump for small to medium displays, fountains, waterfalls or ornaments.

All pumps have a double outlet meaning you can run two features from one pump. eg, a waterfall and fountain and the flow to each can be controlled independently. 3 year guarantee up to 3 fountainheads (as shown).

Model	Fountain Heads	Hose Size	Was	RRP	OUR PRICE	SAVE
Cascade 450	A,B	12	£44.99	£99.99	£34.99	£10
Cascade 700	A,B,C	12	£55.99	£126.99	£39.99	£16
Cascade 1500	A,B,C	25	£75.99	£171.99	£59.99	£16
Cascade 4000	A,B,C	25	£118.99	£265.99	£99.99	£19



SUMMER SALE

Save up to 29%

Bestseller



Note: No 'T' piece with 450 & 700

3yr Guarantee

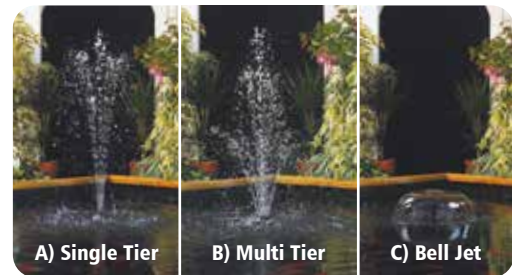

# Fountain/Filter Pump Hybrid



pondXpert

Front nozzle allows easy cleaning by garden hose

## PondXpert Flowmaster Pond Pump

At last a genuine solids-handling pump that can double as fountain pump when required. By removing the secondary (internal) strainer cage (supplied with 3500 & 4500 models only) the tough impellor can handle solids up to 5mm large. Simply reattach the internal strainer to utilise the fountain attachment. *Simple but brilliant idea!*

### A genuine fountain pump



### A genuine filter pump

Tough impellor handles solids with ease! In our test pond the Flowmaster has worked continuously for 3 years so far. Evidence of the solids dealt with can be seen below in the 'before' and 'after' pics of our test bay.



Model	Max Flow LPH	Flow @ 1m	Hose	Watts	RRP	OUR PRICE
Flowmaster 3500	3500	2500	20/25/32/40	42	£119.99	£59.99
Flowmaster 4500	4500	3600	20/25/32/40	75	£139.99	£69.99
Flowmaster 5000	5000	4000	20/25/32/40	100	£159.99	£79.99

### Add lights if required

Flowmaster fountain attachment comes with a bracket that can be used to attach PondXpert pond lights.



## Solar - Fountain Pumps

*Utilise the Sun's rays to power your pond*

- No outdoor power required
- Free running costs



## Entry-Level Solar

### Blagdon Liberty Solar Floating Fountain Pump 180

Floats on pond surface and works in direct sun.

2.2W Panel. Max Flow 180LPH.

Includes 5 attractive fountain heads to create a selection of attractive water displays. Bird bath fittings to keep the fountain centred and holds in position.

RRP £46.99 **Our Price £24.99**

**NEW**



### PondXpert SunnyPump 250 Solar Pump with extra oomph!

Works in direct sunlight. 1.5W solar panel.

Maximum fountain height 60cm.

Maximum flow rate 250lph.

RRP £59.99 Was £29.99

**Sale Price £24.99**



**SUMMER SALE**

### PondXpert SunnyPump 900

Super powerful solar fountain pump. Feature-packed, operates in direct sunlight only.

Max Flow 900lph 10W solar panel

Max fountain height 2m.

RRP £199.99 Was £99.99

**Sale Price £79.99**

**NEW**



## Jumping Jet Solar Pumps



'Jumping Jet' Mode!



Premium Battery-BackUp Fountain Pumps with additional feature

### PondXpert SolarPulse 250 & SolarPulse 500

We love our solar pumps but sometimes feel that the water jet display can become a bit predictable. These new solar pumps can be selected to emit a spitting truncated jet of water as well as the usual continuous flow.

Max Flow: 250LPH

Power: 2 Watts

Battery: Lithium 3.7V

Outlet: 8mm

RRP £99.99

**Our Price £59.99**

Max Flow: 500LPH

Power: 9 Watts

Battery: Lithium 9V

Outlet: 12mm

RRP £169.99

**Our Price £79.99**

### EXCLUSIVE TECHNOLOGY

## Pond-side Ornamental Spitters

Includes 8mm and 12mm hose (2m length). Fits most pumps including PondXpert SolarPulse

### Frog Spitter (Small) 14 x 11 x 21cm (LWH)



Recommended optimal pump match SolarPulse 250

RRP £49.99 **Our Price £24.99**

### Frog Spitter (Large) 33 x 24 x 33cm (LWH)



Recommended optimal pump match SolarPulse 500

RRP £69.99 **Our Price £34.99**

### Spitter + Solar Pump Bundle Deals

#### Small Frog Spitter + Solar Pulse 250

Usual Price £84.98 **Deal Price £69.99** You Save £14.99

#### Large Frog Spitter + Solar Pulse 500

Usual Price £114.99 **Deal Price £94.99** You Save £19.99

### More Spitter Bundles Online

**eg, Small frog + SunnyPump 250 £49.99**

**Note:** This combination would only operate when sun is shining

### 2 Lengths of hose included!

#### 2 Hose Pieces

Spitters are supplied with 2 hoses enabling easy connection with most pumps (Hose lengths 2m)

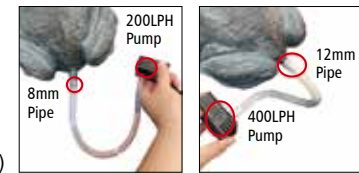

# Solar - Fountain Pumps

## PondXpert Solar Power Extension Cable 5m

This cable is compatible with all PondXpert solar pump sets.

It enables the user to increase the distance between pump and solar panel. Very handy when you are seeking the sunniest position for your panel.

RRP £15.99 **Our Price £7.99**



## Solar Pumps - Battery Boosters

The solar pumps shown on the opposite page (which are also used to power the features on this page) contain lithium batteries that can be powered up using mains electricity.

This is particularly useful during an elongated period of cloud or if the feature is to be run indoors (eg, in a conservatory).

### 5v Adapter

(SolarShower 200)

RRP £19.99

**Our Price £9.99**

### 9v Adapter

(SolarShower 300 to 800)

RRP £25.99

**Our Price £12.99**



## PondXpert SolarShower Pumps

Next Generation solar pumps from PondXpert boast the latest lithium battery technology.

Model	Solar Panel Wattages	Max Water Lift	Voltages	Lithium Battery
SolarShower 200	2w	0.8m	5V	3.7v
SolarShower 300	3w	1m	9V	7.4v
SolarShower 400	5w	1.2m	9V	7.4v
SolarShower 600	7w	1.4m	9V	7.4v
SolarShower 800	9w	2.0m	9V	7.4v

### Feature-packed

Battery Run-Time 6-8 hrs. Cable length 5m

A selection of 4 different fountain head attachments are included with every pump to enable creation of different effects.

Auto nighttime illumination with optional 4 bulb LED lighting ring (supplied).

### Pushing water through a feature /small waterfall

As well as creating a fountain display the pumps can be used to power a spitter or water feature. We recommend the use of 10mm diameter connection hose.

**10mm hose** 1 metre length **£4.99**

**10mm hose** 2 metre length **£8.99**

**12mm hose** 1 metre length **£5.99**

**12mm hose** 2 metre length **£9.99**

Solarshower 200/300 take the 10mm hose

Solarshower 400/600/800 take the 12mm hose

# Latest Technology: Works in sun, cloud . . . even indoors!

Solar Panel • Lithium Battery • LED Lights • Plug into Mains\*



## SolarShower 200

Max Flow: 200 Ltrs per hr

RRP £119.99 Was £59.99

**Sale Price £49.99**



## SolarShower 300

Max Flow: 300 Ltrs per hr

RRP £139.99 Was £69.99

**Sale Price £59.99**



## SolarShower 400

Max Flow: 400 Ltrs per hr

RRP £159.99 Was £79.99

**Sale Price £69.99**



## SolarShower Float 200

Updated version of this bestselling solar feature. Now features higher watt panel and multi-coloured lighting effects.

RRP £139.99 WAS £69.99

**Sale Price £49.99**

## Multi-Program Remote Control

- A. Timer (Runs for 60mins then stops)
- B. LED Lights
- C. High/Low Flow
- D. On/Off



- **Solar Panel Power:** 2 watts
- **Max. water Flow:** 200lph
- **Battery Power:** Lithium 3.7v



## SolarShower 600

Max Flow: 600 Lph

RRP £199.99 Was £99.99

**Sale Price £89.99**

## SolarShower 800

Max Flow: 800 Lph

RRP £239.99 Was £119.99

**Sale Price £109.99**

All Fountains Illuminate at night!



## PondXpert SolarShower 1600

Extra-Power solar fountain pump to create bigger display. This pump utilises twin solar panels (2 x 10W) to produce a higher maximum flow of 1600 LPH. The fountain can be controlled by use of the Control Unit which houses the 12V battery.

- High power 1600LPH flow
- LED light for night-time usage
- Battery back-up enables pump to work in sun, shade or at night
- Mains adapter available to boost power when sunlight in short supply
- Features 'Bell' and 'tiered' fountain heads
- Connect 12mm hose to divert flow to a pond or water feature

RRP £399.99 Was £199.99 **SALE PRICE £169.99**



## PondXpert EcoFilter

For maximum performance we recomend use of PondXpert EcoFilter with these products. This prevents pump blockages so reducing maintenance. See page 44.



Water Lift Max: 2.7m  
 Max Fountain Height: 1.8m  
 Max Flow: 1600LPH  
 Max Power: 20W  
 Panel to Pump Cable 5m Length

**12V Mains Adapter**  
 Enables user to charge pump up indoors.  
 RRP £29.99 **Our Price £14.99**  
 New 5m Universal Power Extension Cable allows for flexible panel positioning **£7.99**  
 (See pg 40)

## Solar - XL Pumps



**NEW**

### SolarShower 3000 Booster Panel

25W Panel with connector. Helps to boost flow of your 3000 Pump. Also assists in reducing battery charging time.



RRP £99.99 **Our Price £49.99**

### PondXpert SolarShower 3000

Professional solar pump designed to power a waterfall or pond filter. This pump utilises twin solar panels (2 x 25W) to produce 50 Watts of power.

RRP £659.99 Was £329.99 **SALE PRICE £299.99**

### SolarShower 3000 Control Unit & Battery

Flow can be controlled by use of the optional Control Unit which houses an 18-21V battery.

RRP £199.99 **Our Price £99.99**

**21V Mains Adapter**  
 Enables user to charge pump up indoors.  
 RRP £39.99  
**Our Price £19.99**



### PondXpert SolarShower 3000 Complete sets

	Usual	Sale
<b>Direct Sun Version</b>	<b>£329.99</b>	<b>£299.99</b>
<b>Battery Version</b>	<b>£399.99</b>	<b>£349.99</b>

Sets include:

- Pump & panels set
- Control Unit & Battery\*
- Mains Adaptor\*
- Save up to £149.98 on buying Set components separately

\*Battery version only



Lift Max: 3.2m  
 Max Flow: 3000LPH  
 Max Power: 50W.

Three hoesetails supplied 20mm, 25mm, 32mm.



Optional control unit housing 18-21V Battery.



## Solar - UVC

Those clever engineers at PondXpert have come up with a new pond product we believe is a world first! A solar powered ultra-violet clarifier to stop pond water going green.

This technological breakthrough means that 'wire-free' water gardening becomes a reality!



Panel Power: 3W  
UV Bulb Power: 5W  
Panel Lead Length: 5m  
Inlet size: 12mm  
Battery: Lithium

**EXCLUSIVE** **NEW**

**Note:** Solar UVC needs to be paired with a pump to push water past the UVC bulb. This pump power should be 400 to 1000LPH in flow strength.

### PondXpert Solar UVC 5W

The Solar UVC is designed to illuminate for two hours per day. Simply set once then the onboard memory will ensure this same start time is selected daily. The Clarifier unit itself is submersible and designed to be placed underwater with the Panel positioned dry/pond-side. The 5 Watt UVC bulb is powered by the sun with excess solar energy stored in the lithium battery.

RRP £159.99 Was £79.99 **Sale Price £49.99**

**SUMMER SALE**

## Solar - Filter

Most solar pond pumps are designed to create a fountain - if the fountain is disconnected and hose attached to the outlet the water can be fed to a different use (eg, small waterfall, pondside spitter or UVC). BUT Solar pumps tend to be small and light in weight and their small impellers that can get clogged with dirt very easily. Without protection we've found they aren't really suitable at producing a reliable flow for a pond.

To use a solar pump for this alternative non-fountain use it is strongly advised that an underwater filter be used. This holds the pump steady in upright position and collects dirt and debris before they reach the pump.



Model	Pond Size Lts	UV Watts	RRP	OUR PRICE
EcoFilter 2000	2000	0	£79.99	<b>£39.99</b>
EcoFilter 4000	4000	0	£99.99	<b>£49.99</b>

Both the above filters need the addition of ballast to keep them submerged. (eg, Gravel £6.99 or Zeolite £16.99).

### PondXpert Solar Filter Box (TripleAction)

The filter box used in the PondXpert TripleAction Solar pumps is available for separate purchase. It is similar in design and size to the PondXpert Eco-Filter 2000 shown above but comes complete with gravel and biomedica (biological cleaning and ballast). Suitable for all solar pumps.

RRP £99.99 **Our Price £49.99**



## Solar All-in-One Pond Filtration System

Taking advantage of the latest technological solar UVC and filtration breakthrough we are proud to be able to bring to your attention the first solar 'All-in-One' Pumps.

Now the water in a small pond can be kept clean and healthy without any mains electric wiring or running costs!

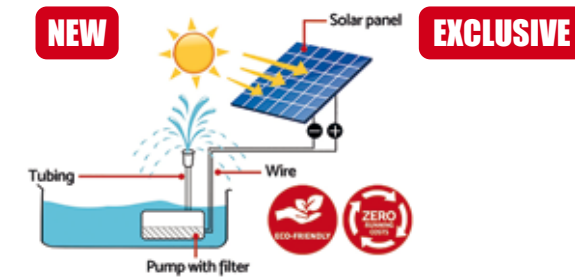

**NEW** **EXCLUSIVE**

Solar panel  
Tubing  
Wire  
Pump with filter

**ECO-FRIENDLY** **ZERO COSTS**

### Solar Powered Pumping with renewable energy

- ✓ Enables a pond to be positioned anywhere without need to access mains electric
- ✓ The first pond filtration system with zero running costs!
- ✓ Mains adapter included for emergency use (charging battery) during prolonged periods of poor weather.

**pondXpert**

Model	Max Pond Lts	UV Watts	Max Flow	Panel Power	Outlet Size	RRP	OUR PRICE
TripleAction Solar 800	800	5W	450LPH	9W	12mm	£299.99	<b>£149.99</b>
TripleAction Solar 1600	1600	5W	850LPH	12W	12mm	£399.99	<b>£199.99</b>

**First ever completely solar pond filtration system.**  
Can be installed anywhere and mains booster means it can run in all weather conditions.

### TripleAction Filtration Set Components



# Garden Ponds - Energy Update



## UK Electricity Costs **30% Price Drop!**

Movement is essential in a garden pond. In nature this occurs naturally in streams, rivers and lakes. To create our own 'aquatic universe' in our own properties we have to rely on electricity to create this movement.

Fortunately energy costs are on their way down. From a high of 34p this time last year to 24p from April 1st 2024. In July a further cut is forecast as wholesale electricity costs have dropped rapidly.

### Example Pump Running Costs (excludes standing charge)

Pump Model	Min W	Max W	Annual Running Cost	Pump	Watts	Running Cost
VariFlow 10000	25	85	£52.56 - £178.70	TripleAction 2000	24	£50.46
VariFlow 20000	34	187	£71.48 - £393.15	TripleAction 6000	45	£94.61
VariFlow 30000	45	385	£94.61 - £809.42	TripleAction 15000	55	£115.63
VariFlow 42000	105	450	£220.75 - £946.08			
VariFlow 52000	180	600	£378.43 - £1,261.44	EasyClear 3000	25	£52.56
				EasyClear 6000	40	£84.10
				EasyClear 9000	55	£115.63
MightyMite 2000	35		£73.58			
MightyMite 3000	55		£115.63			
UltraFlow 3000	10		£21.02			
UltraFlow 5300	30		£63.07			
UltraFlow 10000	80		£168.19			
UltraFlow 20000	180		£378.43			

## Power Costs due to drop a further 7% in July

### Pond Pump Running Costs

Your pump is the heartbeat of your pond and it is this element that is the most powerful and expensive to run.

Fortunately we have already been working hard over the years on sourcing pumps with low wattage 'eco' motors.

We have been also focussing and expanding our range of solar pumps that have the benefit of zero running costs.

### Variable Flow Pumps

The most sophisticated variable flow pumps can have their power turned up or down as required.

#### Observations

The additional price premium for a pump with an 'eco' motor (UltraFlow/VariFlow) is soon paid off by savings on running costs.

Costs shown are based on running the pumps 24hrs/365 days annually. In reality pumps could be turned off during the cold season halving this cost.

# Filter Pumps

## MightyMite

Not sure how these new pumps from PondXpert got their name - it could be the mighty power they generate from their compact size or it could be the mighty savings you make by choosing this pump! Perfect for smaller ponds (up to 6000 litres - 1320 gallons). Pumps can handle 4mm solids and include 10m power cable, a multi-stage hosetail and a 3 year guarantee



**3yr Guarantee**



Perfect 'Starter' Pump. Solids-handling with energy-efficient motor.

Model	Max Flow LPH	Flow @ 1m	Watts	Hose	RRP	OUR PRICE
MightyMite 1000	1000	300	20	12-25	£69.99	<b>£34.99</b>
MightyMite 1500	1500	850	25	20-32	£89.99	<b>£44.99</b>
MightyMite 2000	2000	1100	35	20-32	£99.99	<b>£49.99</b>
MightyMite 2500	2500	1700	45	20-32	£109.99	<b>£54.99</b>
MightyMite 3000	3000	2100	55	20-32	£129.99	<b>£64.99</b>

## PondXpert "Stumpy"

Faux Oak Seat/Shelter. Realistic oak stump - resin garden feature.

- Decorative feature
- Weather shelter for pondside electrics
- Garden seating (max weight 150kg)
- Dimensions: 38x38x47cm (LWH)

RRP £249.99  
WAS £124.99  
NOW **£99.99**



Blends seamlessly into the landscape

Ideal for protecting LCD Controllers & Switchboxes



Save 20%



Simple 'tools free' access to pump inside strainer cage. Makes cleaning any blockages simple.



Three hosetails included in scope of delivery. Additional convenience as no need to cut a multistage hosetail down to maximise flow.



Perfect pump for powering pond filters and/or small waterfalls.

- ✓ **Proven reliability** - pump now ships with a 3 year guarantee
- ✓ **'1500' pump expands model range to five** - enables you to make a more refined choice to suit your needs



# Filter Pumps

## Hozelock Aquaforce

One of our bestselling pumps from a trusted UK brand

The Aquaforce is a reliable solids-handling pump that will work 24/7. There is a choice for every pond size and larger models (6000+) come complete with a second inlet that can be attached to a skimmer or satellite strainer cage.

- Highly economical 'eco' motor.
- Unique Wildlife Protection System: Intake holes can be reduced to 2mm to prevent tadpoles, newts and small fish getting into the cage.
- Smaller pumps (1000-4000) can handle solids up to 6mm
- Larger pumps (6000-15000) can handle solids up to 10mm
- 3 Year Guarantee

**Bestseller**



Save up to 20%

**SUMMER SALE**

## Aquaforce Satellite Strainer Cage

Pulls dirty water from a secondary area of the pond to avoid stagnant spots - attaches to 2nd inlet on models 6000 up.

RRP £71.29 **Our Price £59.99**



# Filter Pumps



"Pump works great with good flow rate. Cage is very easy to open (Probably best on market) with very easy clips for maintenance purposes. Spot on!"

Customer Feefo Review July 2017

## PondXpert UltraFlow

At last we have found a pump that 'ticks all the boxes'. Consider the following features:

- Ultra-low running costs.
- 'Auto-Off' function if water level drops too low.
- Choice of 10 models enables user to make a refined choice.
- Alternative inlet feature (blanked off on initial set-up).
- Alternative inlet can be attached to a skimmer or satellite strainer if required.
- Set includes 2 multi-stage hoses (25/32/38/40mm).
- Can be run submersed or 'dry' (ie, suitable for pondkeepers running a gravity-fed system).
- Designed to run 24/7, 365 days per year (handles 6mm solid particles).
- Tool-free access to pump inside filter cage (easy to access and clear out any blockages).
- Three year guarantee
- Carry handle (very useful when lifting pump out of pond)

All pumps accept hose 25 / 32 / 38 / 40mm and come complete with 10m outdoor power cable

### Filbert Frog's Top Tip

Check your current pump power ratings. An old pump may have a high wattage and these are expensive to run. For instance a 'typical' 5yr old 8000lph pump could be 180W. The UltraFlow is just 70W. Running 24/7 the UltraFlow could save you £208 per year off your electricity bill\*.

### Pump Dimensions:

LWH: 25 x 18 x 11.5cm  
Relatively compact - suits any size of pond

\* Electricity costs vary - please check with your current supplier.

### Price Match Promise - Lowest UK Price Guaranteed\*\*

Model	Max Flow LPH	Flow @ 1m	Hose	Watts	RRP	Was	Sale Price	SAVE
Aquaforce 1000	1000	700	20-40	25	£186.99	£109.99	<b>£89.99</b>	<b>£20</b>
Aquaforce 2500	2500	1850	20-40	30	£229.99	£129.99	<b>£109.99</b>	<b>£20</b>
Aquaforce 4000	4000	3000	20-40	50	£279.99	£159.99	<b>£139.99</b>	<b>£20</b>
Aquaforce 6000	6000	5550	20-40	65	£386.99	£229.99	<b>£199.99</b>	<b>£30</b>
Aquaforce 8000	8000	7400	20-40	95	£459.99	£259.99	<b>£219.99</b>	<b>£40</b>
Aquaforce 12000	12000	10800	20-40	130	£546.99	£299.99	<b>£239.99</b>	<b>£60</b>
Aquaforce 15000	15000	13100	20-40	180	£599.99	£349.99	<b>£279.99</b>	<b>£70</b>



Purchase any Hozelock Aquaforce and claim your **Free Gift worth £34.78**

**Free 5 metre length of pond hose & clips**  
Pond Hose 5m x 40mm (see page 115)



Pond hose & clips

Model	Max Flow LPH	Flow @ 1m	Max Pumping Height	Watts	RRP	OUR PRICE
UltraFlow 3000	3000	1600	2.0m	10	£179.99	<b>£89.99</b>
UltraFlow 3600	3600	2400	2.8m	20	£199.99	<b>£99.99</b>
UltraFlow 5300	5300	3900	3.3m	30	£239.99	<b>£119.99</b>
UltraFlow 6000	6000	4725	4.2m	40	£259.99	<b>£129.99</b>
UltraFlow 8000	8000	6900	5.6m	70	£299.99	<b>£149.99</b>
UltraFlow 10000	10000	8550	6.0m	80	£339.99	<b>£169.99</b>
UltraFlow 12000	12000	11400	6.5m	100	£359.99	<b>£179.99</b>
UltraFlow 14000	14000	12450	7.0m	120	£379.99	<b>£189.99</b>
UltraFlow 16000	16000	14775	7.5m	155	£399.99	<b>£199.99</b>
UltraFlow 20000	20000	17250	6.0m	180	£459.99	<b>£229.99</b>

## Filter Pumps - Variable Flow



### Blagdon Amphibious IQ

This new pump from Blagdon is powered by the latest digital motor technology. Now you can see exactly how much power your pump is using and choose to turn the power up or down. This means you can lower the flow at nighttime (eg, to reduce noise from a waterfall disrupting neighbours) or increase the flow - eg, during hot weather when the pond needs more oxygen. The digital motor requires minimal power to run so you save on energy costs too!

#### DIGITAL MOTOR TECHNOLOGY

Digital motors convert less electrical energy to heat than conventional pump motors, saving energy. Microprocessor control and monitoring allows for a host of convenient and energy saving features for your pond or water feature.

**Motor protection system**  
If the pump detects that the motor is clogged or jammed, it will pause and display scrolled text: **MOTOR JAMMED. CLEAN IMPELLER. CLEAN ROTOR.** When the clogging is removed the pump can safely restart.

**Run dry protection system**  
If the pump detects it has run out of water it will pause and display scrolled text: **WATER LOW. ADD WATER.** Simply ensure there is a safe level of water and restart pump.

**Flexible power usage control and display**  
Stop, start, increase or decrease power and flow at the push of a button for optimum performance and maximum energy saving.

**Soft start**  
When the pump is turned on, the flow will slowly increase to its preset position. This reduces pump wear and reduces stresses on pipework and filters fitted to the system, decreasing the risk of leaks and damage.

Outlet: 20/25/32/40mm

Model	Max Rate	Power Use	Max Height	RRP	OUR PRICE
<b>IQ Pump 2250-4500</b>	2250-4900 lph	15 - 25 watts	3.0 metres	£246.99	<b>£192.99</b>
<b>IQ Pump 3000-6000</b>	3000-5900 lph	17 - 35 watts	4.2 metres	£262.99	<b>£204.99</b>
<b>IQ Pump 4500-9000</b>	4500-8700 lph	30 - 60 watts	4.5 metres	£317.49	<b>£254.99</b>
<b>IQ Pump 6000-12000</b>	6000-11200 lph	40 - 85 watts	5.0 metres	£352.99	<b>£279.99</b>

### PondXpert VariFlow Pond Pump - Accessories

Bestselling variable flow pumps New for 2021 is a range of accessories to make these pumps even better.

#### PondXpert VariFlow Fountains

Create a 'geyser jet', 'tiered fountain' or 'bell jet'. Kit includes a T Piece with 20/25/32mm hose tail.

**10000 Fountain** RRP £39.99 **Our Price £19.99**

**20/30000 Fountain** RRP £59.99 **Our Price £29.99**



VariFlow 30000 Geyser Fountain in action

#### VariFlow Expanded Strainer Cages

Reduce maintenance by plugging in one of these large strainer cages to your VariFlow Pump.

**10000 Strainer** RRP £39.99 **Our Price £19.99**

**20/30000 Strainer** RRP £49.99 **Our Price £24.99**



## Filter Pumps - Variable Flow



### PondXpert VariFlow Pond Pump

- Create & control dramatic water displays
- Divert extra flow to other areas
- **Save £££s** by reducing energy bills (perfect for winter running)

Multi-Hosetail Included: 25/ 32/ 40/ 50mm (1-2")

**Pumps creating a storm in the fishkeeping community**

Model	Max Rate	Power Use	Max Height	RRP	OUR PRICE
<b>VariFlow 10000</b>	4400lph to 9200lph	25 - 85 watts	5.0 metres	£379.99	<b>£189.99</b>
<b>VariFlow 20000</b>	9000lph to 20000lph	34 - 187 watts	7.0 metres	£499.99	<b>£249.99</b>
<b>VariFlow 30000</b>	12000lph to 30000lph	45 - 385 watts	10.0 metres	£759.99	<b>£379.99</b>

Low running costs from the latest motor & 3 years guarantee.

**1 Pump - 23 controllable flow rates**

#### Reduce flow = reduce energy savings

Turn 10,000lph pump to 4400lph save £179 per year.

Turn 20,000lph pump to 9000lph save £456 per year.

Turn 30,000lph pump to 12000lph save £1,013 per year\*.

Never before has a pondkeeper been able to control the flow like this (well, not without paying many hundreds of pounds for pro kit). VariFlow can be used submersed or 'dry'.

(\*savings based on 34p/kWh)

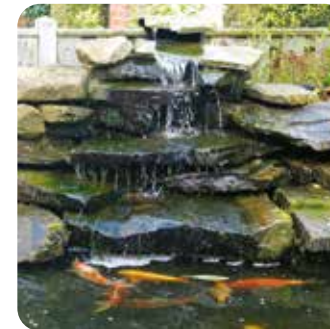

3 Variflow Settings in action

# Filter Pumps - Variable Flow

## Evolution Aqua VariPump

The Evolution Aqua VariPump is a controllable pond pump that's suitable for large ponds. It features a six pole, three phase motor and is quiet when running, and reliable. The VariPump is powerful enough to run the largest ponds and filters, in the most demanding of situations. It can also be used in and out of the pond, and hose-tail fittings are included.



- 3 Year Guarantee
- 2 inch outlet, (1.5" on 10k)
- 25/32/38/40mm outlet
- 10m Power Cable
- 3m Cable to control unit.



Model	Flow Rate	Power Use	Max Height	RRP	OUR PRICE
VariPump 10000	Max 10,000 LPH	31 - 92 Watts	3.1 metres	£209.99	<b>£199.99</b>
VariPump 20000	5520 to 19200 LPH	51 - 190 Watts	5.5 metres	£274.99	<b>£264.99</b>
VariPump 30000	Max 30,000 LPH	56 - 450 Watts	5.5 metres	£424.49	<b>£404.99</b>

## PondXpert VariFlow XL

New for 2023 these super powerful variable flow pumps dedicated to the serious pondkeeper.

These ultra-powerful pumps are designed for those who need a massive amount of flow.

The 52,000 LPH model is the most powerful pump we have ever sold.

The 42,000 LPH can operate at 30,000 LPH at just 105W running costs.

3 inch inlet/outlet Can be run dry

Supplied with a free 2" pipe conversion kit. This includes reducers and optional strainer cage as shown in image.



Model	Flow Rate	Power Use	Max Height	RRP	OUR PRICE
VariFlow 42000	32060 to 42000 LPH	105 - 450 Watts	6.5 metres	£1099.99	<b>£549.99</b>
VariFlow 52000	30658 to 52050 LPH	180 - 600 Watts	8.5 metres	£1199.99	<b>£599.99</b>

## PondXpert VariFlow Strainer+ Pump

These variable flow pumps dedicated to the traditional ornamental pond owner. VariFlow pumps are growing in popularity with many first adopters running them 'dry' for use with koi ponds. These new Strainer+ models offer all the benefits of the original VariFlow but come complete with a strainer cage for submersible use. (They can be still run dry if required).



- 3 Year Guarantee
- 2 inch outlet
- 25/32/38/40mm outlet
- 10m Power Cable
- 3m Cable to control unit.



Model	Flow Rate	Power Use	Max Height	RRP	OUR PRICE
VF Strainer+ 5000	2800-5000 lph	24 - 43 Watts	4.0 metres	£359.99	<b>SOLD OUT</b>
VF Strainer+ 10000	4400-10000 lph	30 - 92 Watts	5.6 metres	£419.99	<b>£209.99</b>
VF Strainer+ 20000	9700-20000 lph	52 - 205 Watts	7.5 metres	£539.99	<b>£269.99</b>



Adjustable 2" outlet for virtually any direction



Convenient handle built into the outer cage



Optional large strainer cage

### PondXpert VariFlow Strainer+ Pump Settings

Model 5000				Model 10000				Model 20000			
Level %	Power (Watts)	Flow Rate (LPH)	Max Height	Level %	Power (Watts)	Flow Rate (LPH)	Max Height	Level %	Power (Watts)	Flow Rate (LPH)	Max Height
100	43	5000	4.0m	100	92	10000	5.6m	100	205	20000	7.5m
90	40	4600	3.8m	90	85	7800	5.5m	90	190	18000	7.1m
80	38	4500	3.7m	80	79	7500	5.3m	80	175	17400	6.7m
70	37	4300	3.6m	70	72	7200	5.0m	70	159	16800	6.3m
60	36	4200	3.4m	60	66	6900	4.7m	60	143	16100	5.8m
50	34	4000	3.3m	50	60	6600	4.4m	50	128	15300	5.4m
40	32	3800	3.1m	40	54	6200	4.1m	40	114	14500	4.9m
30	30	3700	3.0m	30	48	5800	3.8m	30	96	13500	4.3m
20	28	3500	2.7m	20	41	5300	3.4m	20	80	12400	3.7m
10	26	3300	2.6m	10	36	4900	3.0m	10	66	11000	3.1m
1	24	2800	2.3m	1	30	4400	2.7m	1	52	9700	2.6m

# Pond Filtration

## How it works

Your pond pump is designed to suck up dirty pond water and push it to a waterfall and/or filter. Filtration is the process by which your pond is cleaned of impurities. Once the water reaches the filter it usually passes through three key stages:

### 1 UVC Radiation

If your filter has a built-in UV unit this exposes the water to UVC rays which cause microscopic single cell algae to flocculate (that is to stick together to form larger pieces). This action causes this suspended algae to die and fall to the bottom of the pond. This clears the water and the solid particles are sucked up by the pond pump.

### 2 Mechanical Filtration

Dirt such as fish waste and algae particles generated by UVC radiation are caught in physical mechanical barriers. Foams are a typical example - often with multiple grades to catch even the smallest pieces.

### 3 Biological Filtration

Dirt-free water then passes through a bed of bio-media. This material will often have a multi-surface appearance for healthy bacteria to stick to and thrive. Such bacteria break down ammonia into Nitrite. Nitrite is broken down into nitrate.



# Pressurised Filters

## PondXpert Filter Caps

Decorative, highly realistic rock and timber effect covers. Sandstone, Slate and stump finishes blend easily into the landscape.

Introduced in 2023 these Caps are now available at a special 30% Discount.



### Tree Stump Cap Large

Was £179.99 **NOW £125.99**

**Medium caps** fit SpinClean Filter models (inc. AUTO) 4500-20000 **Large Caps** fit SpinClean Filter models (inc. AUTO) 30000-75000



### Sandstone Cap

Medium Was £139.99 **NOW £97.99**  
Large Was £179.99 **NOW £125.99**



### Slate Cap

Medium Was £139.99 **NOW £97.99**  
Large Was £179.99 **NOW £125.99**

Custom built in the UK for PondXpert SpinClean Filters

## Main types of pond filters available:

### Flow-through Filters (pages 56-57)



The traditional 'Box' filter sits pondside or at the top of a waterfall. Pond water is pushed into one end and returns via gravity from the other. These filters are generally larger and provide a massive area of filtration media to cope with larger ponds.

### Koi & Large Capacity Filters (pages 62-65)

### Pressure Filters (pages 58-61)



A more modern approach is to house the filter media into an airtight cannister. The water enters the filter under pressure and leaves it under pressure allowing the filter to be hidden. Great for smaller ponds - these filters provide maximum landscaping opportunities.



Filter without Cap



Slate Cap in position

## PondXpert Filtobox 6000 & 12000

Introduced in 2010 these flow-through filter boxes consistently top our bestsellers chart. Feature-packed yet very competitively priced it is no wonder they are a firm favourite with our customers.

- Top outlets mean filters can be buried up to 2/3 of height
- High quality construction
- Sludge drain for easy cleaning
- Easy Access to UVC.

Inlets 25-40mm Outlet 70mm (50mm on 6000)

Outlet extension pipe pg113

6000 now supplied with free 28cm extension pipe & clip

Dimensions (cm LxWxH)

6000 - 37 x 27 x 39

12000 - 55 x 38 x 44



Best for Value

Add a pump & save £££'s

Model	Pond Size Ltrs	UV Watts	RRP	OUR PRICE
Filtobox 6000	6000	9	£259.99	£129.99
Filtobox 12000	12000	18	£399.99	£199.99

Set Name	Suggested Pump	SALE PRICE	Save
Fbox 6000 Set	UltraFlow 3000	£149.99	£69.99
Fbox 12000 Set	UltraFlow 6000	£239.99	£89.99

## PondXpert Filtobox Sets

Dirty water enters the filter through the multi-stage hose inlet. The water fills the entry chamber, then spills into intermediate section before passing through the final chamber. Each chamber/zone contains filter foam and bio media. Once installed you may choose to try different grades of media in the different sections. **Note** - pump in photo differs from that supplied in Set



Complete Filter Systems - everything you need

Filter Pump, Pond Hose, Clips, UVC Filter.

25mm hose (x5m) and clips (pair) included in all sets

For other 'Set' Offers See Pgs 6-9

Model	Pond Size	Separates Cost	OUR PRICE	Save
FiltoBox 3000 & MightyMite 2000	3000 Ltrs	£163.46	£109.99	Sold Out
FiltoBox 4500 & MightyMite 2500	4000 Ltrs	£178.46	£129.99	Sold Out
FiltoBox 6000 & MightyMite 3000	6000 Ltrs	£218.46	£149.99	£68.47
FiltoBox 12000 & UltraFlow 6000	12000 Ltrs	£353.46	£249.99	£103.47



## Flow-through Filters UVC Included

### Lotus Green Genie

Popular entry level filters. Inlet tap to regulate flow into tank.

Inlet Size:

20/25mm 2500 to 12500

20/25/32mm 18000 to 48000

Outlet Size:

32mm 2500 to 12500 (x2 on 12500)

50mm x 2 18000 to 48000.



Add a pump & save £££'s

Model	Pond Size Ltrs	UV Watts	RRP	OUR PRICE	Set Name	Pump in Kit	OUR PRICE	Save
Green Genie 2500	2000	7	£126.99	£109.99	GG 2500 Set	MightyMite 1500	£139.99	£14.99
Green Genie 3500	3000	10	£142.99	£119.99	GG 3500 Set	MightyMite 2000	£149.99	£19.99
Green Genie 6500	4000	18	£152.99	£129.99	GG 6500 Set	MightyMite 2500	£159.99	£24.99
Green Genie 12500	6000	18	£182.99	£159.99	GG 12500 Set	FlowMaster 3500	£179.99	£49.99
Green Genie 18000	9000	18	£229.99	£199.99	GG 18000 Set	FlowMaster 4500	£219.99	£59.99
Green Genie 24000	12000	25	£289.99	£249.99	GG 24000 Set	UltraFlow 6000	£319.99	£59.99
Green Genie 30000	15000	25	£382.99	£329.99	GG 30000 Set	UltraFlow 8000	£399.99	£79.99
Green Genie 48000	20000	2 x 25	£469.99	£399.99	GG 48000 Set	UltraFlow 10000	£469.99	£99.99
Green Genie 60000 <b>NEW</b>	20000	2 x 40	£547.99	£439.99	GG 60000 Set	UltraFlow 14000	£529.99	£99.99

Dimensions (cm LxWxH) 2500/3500/6500 - 38 x 27 x 30, 12500 - 46 x 32 x 41, 18000/24000 - 55 x 45 x 31, 30000/48000 - 64 x 46 x 46

### Lotus Clear Pond Filters

Advanced 7 Stage filter with larger UVC and quick action back flush (de-sludge system)

- Red Brush chamber for heavy solids
- Blue Foam cartridges chamber
- Green, white & blue graded foams
- Top outlets - can be partly buried
- Good enough filter for koi/mixed stock. (1/2 volumes for koi in table)



Dimensions (cm)

18 - 46 x 30 x 41, 25 - 54 x 40 x 39,

50 - 64 x 46 x 49, 80 - 78 x 58 x 69

Add a pump & save £££'s

Model	Pond Size Ltrs	UV Watts	RRP	OUR PRICE	Recommended Pump	OUR PRICE	You Save	Upgrade to Hz Aq'force Pump	OUR PRICE	Save
Clear Pond 18	9000	18	£244.99	£209.99	UltraFlow 3000	£249.99	£49.99	Aquaforce 4000	£319.99	£49.99
Clear Pond 25	18000	25	£359.99	£309.99	UltraFlow 6000	£369.99	£69.99	Aquaforce 6000	£449.99	£89.99
Clear Pond 50	27000	50	£514.99	£444.99	UltraFlow 10000	£519.99	£94.99	Aquaforce 8000	£619.99	£84.99
Clear Pond 80	36000	80	£659.99	£549.99	UltraFlow 14000	£629.99	£109.99	Aquaforce 15000	£799.99	£99.99

# Pressurised Filters

## PondXpert EasyFilter

These new filters are a joy to use - simply rock the switch to the 'clean' position to backflush the filter of accumulated dirt via the special waste outlet. This dirty water can be directed to your drain or flowerbeds.



- Easy clean feature
- In-built UVC for clear water
- Gradiated foams for mechanical filtration.
- Biomedia for biological filtration.
- 30,000 was a bestseller last year now range extended to suit all sizes of garden pond.

So easy to clean... 'Rocker' handle switches from 'clean' to 'waste'.



Three inlet/outlets as found on more expensive filters. 20-40mm Inlet, Outlet & Waste (12-25mm 4500)



## EasyFilter 20,000+

Introduced in 2010 these large pressure filters proved their reliability and were a real hit with our customers. Their large capacity mean that pondkeeper's with bigger ponds can now enjoy the benefits of pressurised filtration. The bigger filters come complete with increased features but still at a highly competitive price.

**Dimensions (cm)** 4500 - 27 x 37, 9000 - 34 x 44, 12000 - 34 x 52, 20000 - 41 x 59, 30000 - 41 x 69



Tilt & pivot handle to adjust flow to 'waste'

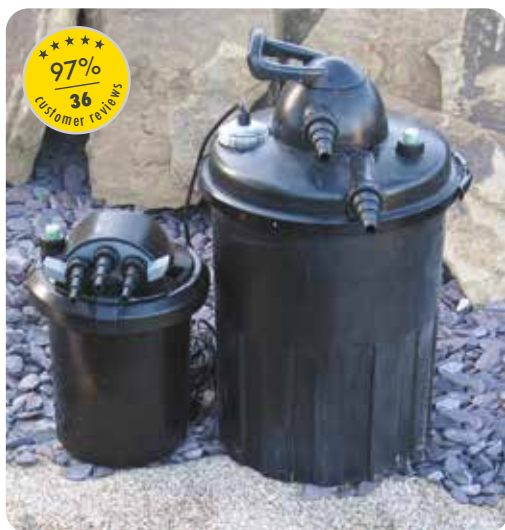

Easy Change UVC (20,000 & 30,000)



Filter can be buried up to lid as shown

### Add a pump & save £££'s

Model	Pond Size Lts	UV Watts	Was	OUR PRICE
EasyFilter 4500	4500	7	£199.99	£99.99
EasyFilter 9000	9000	9	£279.99	£139.99
EasyFilter 12000	12000	11	£339.99	£169.99
EasyFilter 20000	20000	18	£459.99	£229.99
EasyFilter 30000	30000	24	£559.99	£279.99

Set Name	Pump in Kit	OUR PRICE	Save
EasyFilter Set 1	UltraFlow 3000	£134.99	£54.99
EasyFilter Set 2	UltraFlow 6000	£179.99	£89.99
EasyFilter Set 3	UltraFlow 8000	£224.99	£94.99
EasyFilter Set 4	UltraFlow 12000	£279.99	£129.99
EasyFilter Set 5	UltraFlow 16000	£329.99	£149.99

# Pressurised Filters



**Hozelock Bioforce** was the original pressure filter. In 2015 the Bioforce Revolution launched. This revamped design completely re-engineered pond filters for the 21st Century - and our customers love it!

This clever product features the **best 'EasyClean' feature we have ever seen**. The secret to the success of this filter is its use of micro block foam filter media rather than the usual 'rings' or 'blocks'. This means the foams shed dirt and debris far more effectively.

- Powerful UVCs prevent green water
- Efficient Biological Filtration (Kaldness K3 media in bottom chamber)
- Diverter valve switches dirty unwanted water to waste outlet
- Hose Inlets 25-40mm.

**Dimensions:** 6000: 27 x 27 x 37cm (LWH), 9000: 27 x 27 x 46cm (LWH), 14000: 40 x 40 x 51cm (LWH),



**The perfect filter upgrade**  
The Recommended pressure filter for koi/mixed fisheries.

### Add a pump & save £££'s Exclusive Value Kits

Set Name	Pump in Kit	OUR PRICE	Save
Bioforce Value 6000	UltraFlow 5300	£349.99	£69.99
Bioforce Value 9000	UltraFlow 6000	£389.99	£89.99
Bioforce Value 14000	UltraFlow 8000	£499.99	£99.99



Model	Gold fish	Koi	UV Watts	RRP	OUR PRICE
Bioforce 6000	9000	6000	18	£465.99	£299.99
Bioforce 9000	13500	9000	24	£549.99	£349.99
Bioforce 14000	21000	14000	36	£677.99	£449.99

Set Name	Pump in Kit	OUR PRICE	Save
Bioforce 6000 Kit	Aquaforce 4000	£424.99	£24.99
Bioforce 9000 Kit	Aquaforce 6000	£524.99	£24.99
Bioforce 14000 Kit	Aquaforce 8000	£619.99	£59.99

# Pressurised Filters

## SpinClean Filters

pondXpert



**SpinClean 20000**  
Free W Boost  
Was 18w now 24w

**SpinClean 12000**  
Free W Boost  
Was 11w now 13w

**4500/6000** 20/25/32mm     **20000** 20/25/32/40mm  
**8000** 12/20/25mm     **30000** 25/40/50mm  
**12000** 20/25/32/40mm     **40000** 32/40/50mm

### Add a pump & save £££'s

Model	Pond Size Ltrs	UV Watts	RRP	OUR PRICE	Set Name	Pump in Kit	OUR PRICE	Save
SpinClean 4500	4500	11	£279.99	£139.99	4500 Set	UltraFlow 3000	£179.99	£49.99
SpinClean 6000	6000	13	£339.99	£169.99	6000 Set	UltraFlow 3600	£219.99	£49.99
SpinClean 8000	8000	13	£399.99	£199.99	8000 Set	UltraFlow 5300	£249.99	£69.99
SpinClean 12000	12000	13	£479.99	£239.99	12000 Set	UltraFlow 8000	£299.99	£89.99
SpinClean 20000	20000	24	£599.99	£299.99	20000 Set	UltraFlow 12000	£349.99	£129.99
SpinClean 30000	30000	36	£839.99	£419.99	30000 Set	UltraFlow 14000	£459.99	£149.99
SpinClean 40000	40000	55	£999.99	£499.99	40000 Set	UltraFlow 16000	£529.99	£169.99

Just look at our test results . . .



Fig. 1



Fig. 2



Fig. 3

We were astonished (and embarrassed!) by the amount of dirt the filter picked up. **Fig. 1** shows the discharge with **Fig. 2** showing the dirt continuing to flow. By **Fig. 3** we were ready to switch the water back to the pond. After completing this very easy cleaning regime a few times in a fortnight the positive results were clearly visible.



pondXpert

## SpinClean Auto Filters

Procedure when it's time to clean:

- 1) Switch Off Pump.
- 2) Turn blue dial so arrow is facing waste outlet.
- 3) UV light turns colour red and the motor turns the cleaning paddle against the sponges.
- 4) After 3 minutes cleaning a beep indicates cleaning is finished.
- 5) Switch pump on to wash dirt away to waste.



**Procedure Update** - Users report that pump doesn't have to be turned off during cleaning. Turn blue dial on/off to clean!

### Add a pump & save £££'s

Model	Pond Size Ltrs	UV Watts	RRP	OUR PRICE	Set Name	Pump in Kit	OUR PRICE	Save
SpinClean+ 4500	4500	11	£339.99	£169.99	4500+ Set	UltraFlow 3000	£199.99	£59.99
SpinClean+ 6000	6000	13	£399.99	£199.99	6000+ Set	UltraFlow 3600	£239.99	£59.99
SpinClean+ 8000	8000	13	£499.99	£249.99	8000+ Set	UltraFlow 5300	£279.99	£89.99
SpinClean+ 12000	12000	13	£599.99	£299.99	12000+ Set	UltraFlow 8000	£339.99	£109.99
SpinClean+ 20000	20000	24	£739.99	£369.99	20000+ Set	UltraFlow 12000	£429.99	£119.99
SpinClean+ 30000	30000	36	£999.99	£499.99	30000+ Set	UltraFlow 14000	£569.99	£119.99
SpinClean+ 40000	40000	55	£1259.99	£629.99	40000+ Set	UltraFlow 16000	£699.99	£129.99
SpinClean+ 50000	50000	55	£1699.99	£849.99	50000+ Set	UltraFlow 16000	£919.99	£129.99
SpinClean+ 75000	75000	60	£1999.99	£999.99	75000+ Set	UltraFlow 20000	£1099.99	£129.99



**New** Bigger **AUTO** for KOI Ponds and Ponds up to 75,000 Ltrs [See Pg 63](#)

Large choice of model sizes  
A perfect filter for every pond!

**SUMMER SALE**



**NEW** Cap (sandstone) showing filter in position.

### SpinClean Filter Caps (Standard and Auto)

Bespoke design to help your filter blend into your water garden surrounds.

Two types. Two finishes. Highly realistic sandstone and slate/grey finish.

**Medium**  
(models 4500-20000) 62x66x23cm LWH  
Was £139.99 **NOW £97.99**

**Large**  
(models 30-75000) 73x62x23cm LWH  
Was £179.99 **NOW £125.99**

**Large Tree Stump Design**  
(mods 30-75000) Was £179.99 **NOW £125.99**

Save 30%

# Koi Filters

## Evolution Aqua EazyPod

Evolution Aqua produce the most modern pond filters on the market today. The EazyPod has been designed with small koi ponds in mind (10,000 litres - 2200 gallons) but it's superior design can also be employed on ornamental/goldfish ponds. In this less demanding environment the EazyPod can handle up to 20,000 Litres (4400 gallons)

### How it works . . . Regular Running

Dirty water enters filter and is drawn to the centre of the pod. Water passes through special Kaldness filter media which traps the dirt. Dirt gets stuck in the filter media - clean water returns to pond.

### How it works . . . Cleaning

Switch off pond pump. Switch on air pump to agitate the filter media. Filter media bubbles up and dirt is dislodged. Run dirt to waste - Switch pump back on.

23inches (58cm) tall and wide

**New Colour Choice**  
All EazyPods now available in green colour finish too!



**EazyPod Complete**

Model	RRP	OUR PRICE
EazyPod	£549.95	£479.95
EazyPod Air	£709.95	£629.95
EazyPod Air 18w UV	£769.95	£679.95

New Auto EazyPods	
Model	OUR PRICE
EazyPod Automatic Air	£769.95
EazyPod UV Automatic	£829.95

Air versions come complete with a 70lph air pump and fittings worth **£174.95** Available in Grey or Green colour finish.

## Nexus 220 & 320 Koi Filters

For larger koi ponds the Nexus Eazy 220 and 320 are proving highly popular with our customers. The concept of the vortex shape with the EazyPod is repeated but the air pump also supplies an outer chamber. This 'floating bed' is full of media and is rich in healthy bacteria to convert Ammonia and Nitrite into harmless Nitrate. The 220 can be used with koi ponds up to 18000 Ltrs (4000 gallons), the larger 320 up to 34000 Ltrs (7500 Gallons)

**Dimensions** (LxWxH)

**210:** 126 x 111 x 85cm **310:** 143 x 132 x 103cm

Model	OUR PRICE	Save
Nexus 220	£1,395.00	-
Nexus 320	£1,595.00	-
Nexus 220 & 95lpm Air Pump	£1,499.99	£194.96
Nexus 320 & 130lpm Air Pump	£1,679.99	£294.96



**Astonishingly small footprint for such an effective filter**

### Nexus Auto-Kits

Automates cleaning

**Gravity Fed Auto Kit £659.95**  
**Pump Fed Auto Kit £549.95**

# Koi Filters



**X2 Floating Biomedia 25L** RRP £79.99  
16mm dia. x 10mm Effectively generates healthy bacteria. **Our Price £39.99**



**Pro 50**  
60x60x81cm

**Pro 75**  
75x75x88cm

## SpinClean AUTO Pro 50 & 75

The first pressure filter designed with Koi-Keeping in mind. Perfect for keeping water clear & healthy in large ponds up to 75,000 Litres (Koi ponds 37,500 Litres). Supplied with X2 Biomedia, a cassette of larger Biomedia & filter foams.

						Add a pump & save £££'s			
Model	Pond Size Ltrs	UVC	X2 Media	RRP	OUR PRICE	Set Name	Pump in Kit	OUR PRICE	Save
Pro 50	50000	55W	35L	£1699.99	£849.99	Pro 50 Set	UltraFlow 16k	£919.99	£129.99
Pro 75	75000	60W	70L	£1999.99	£999.99	Pro75 Set	UltraFlow 20k	£1099.99	£129.99

Both filters accept hose sized 25/40/50mm. 'One Touch' motorised cleaning is activated by twisting blue Control Dial on lid of unit. Chamber capacity of new 75 model is a massive 300 ltrs and pallet delivery is included.



Hand crafted extra large fibreglass chamber (volume 170 Ltrs). 226% bigger than the 40000.



Cut-away image shows internal foams and Floating Bed. Floating Bed creates a home for healthy bacteria.

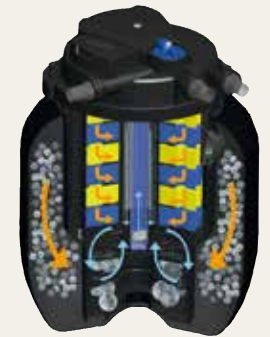

Solid particles from dirty water attach to foams. Water flow then forces biomedia to tumble around the extensive outer skin area.



# Koi Filters

## Evolution Aqua Tempest Pond Filter

Use this innovative filter for crystal clear pond water.

- Easy to install and clean
- Uses 7 litres of K+ Media (supplied)
- Filters down to 1 micron
- 2 Year Guarantee

RRP £274.95 **Our Price £274.95**

Max Pond Size Lts	Inlet Pressure Pipe*	Outlet Pressure Pipe*	Drain/Waste size	Max Flow Rate	Optimum Flow Rate	Dimensions (cm)
5000	1½" (50mm)	1½" (50mm)	1" (32mm)	7500lph	5000lph	110 x 35 x 20

\*To install using flexible hose instead of pressure pipe you'll need to fit a reducing sleeve (EA35050) and a 1½" solvent stepped hoselet (EAHOSE15) inside each slide valve.

## Polishing Filter for removing fine particles

Professional multi-bay filters at a highly reasonable price. There is a good range of sizes with a solution to most pond requirements. Each filter box/bay comes complete with graduated foams, filter mat and bio-media. The foams sit in cassettes and are very easy to remove - simply push the sponges against the grips for easy cleaning.

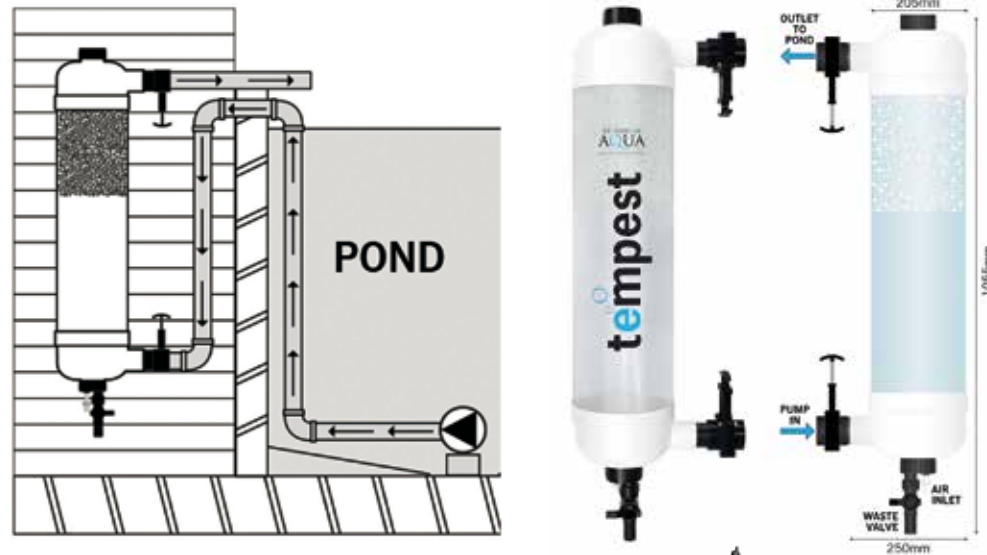

## Evolution Aqua Surge Filter

Introducing the new Evolution Aqua Surge Filter with 18 watt UV. The Evolution Aqua Surge Filter with 18 watt UV is an innovative polishing system for ponds that will help to deliver crystal clear, healthy water.

- All-in-one filter with 18W UVC
- "Dry hands" regime making maintenance simple

Designed to be used in conjunction with any filtration system or stand alone, the Evolution Aqua Surge Filter with 18 watt UV offers additional mechanical and biological filtration with 18 watt UV.

- Simple to install on fence post or wall
- Effectively filters up to 5000 litres



**NEW**

RRP £319.99  
**Our Price £299.99**

## PondXpert MultiChamber Pond Filters

Professional multi-bay filters at a highly reasonable price. There is a good range of sizes with a solution to most pond requirements. Each filter box/bay comes complete with graduated foams, filter mat and bio-media. The foams sit in cassettes and are very easy to remove - simply push the sponges against the grips for easy cleaning.

### "GreenStop Pro" UVC Upgrade

– Enhanced UVC Unit which fits neatly onto the rear of all models as shown (attached to MultiChamber 18000).

- 2 x Inlet Hosetails 20-40mm
- Temperature Dial in lid
- 2 x Outlet pipes. One 70mm and one stepped fits 40/50mm
- Foams, Japanese matting and bio-media included

Dimensions (LxWxH) **9000** - 535 x 465 x 405  
**18000** - 900 x 540 x 405 **36000** - 1335 x 540 x 405



★★★★★  
**100%**  
10  
customer reviews

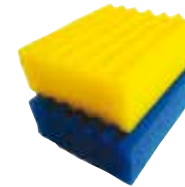

### Replacement Foams

(4 set)

Coarse/Blue **£29.99**  
Fine/Yellow **£29.99**



### Replacement Jap Mat

(single)

One Size Only **£19.99**

### MultiChamber Cleaning Tool

Cleans foam without removing them from filter. **£19.99**



**Maximum Choice – Three Great Models - Twelve ways to Buy!** 3 different box sizes, with or without UVC, add a pump or buy the lot! Build up the filter system that is just right for your pond - *the more you buy the more you save!*



★★★★★  
**100%**  
3  
customer reviews



**Half Price – PondXpert UltraFlow** Filter Pumps.

**Half Price – 36w PRO UV** Usually £149.99 **Only £74.99** with any Multichamber Filter.

Model	Pond Size Lts	RRP	OUR PRICE	Add ½ price 36w UVC	Filter plus Pump	OUR PRICE	Filter plus Pump & UVC	Save
MultiChamber 9000	9000	£259.99	<b>£129.99</b>	<b>£204.98</b>	UltraFlow 6000	<b>£194.99</b>	<b>£299.99</b>	£109.98
MultiChamber 18000	18000	£459.99	<b>£229.99</b>	<b>£304.98</b>	UltraFlow 10000	<b>£314.99</b>	<b>£419.99</b>	£129.98
MultiChamber 36000	36000	£679.99	<b>£339.99</b>	<b>£414.98</b>	UltraFlow 16000	<b>£439.99</b>	<b>£529.99</b>	£159.98

# Pond Cleaning Tools



*These nets are strong enough to fish a pump out of the water*

## PondXpert VariNet HD - Interchangeable Head Hand Net System

**Extra Strong Nets - Ideal for handling big jobs around the pond**

Super strong pond net with hyper-extension telescopic pole. This professional net system has a choice of heads. Max reach 3m (10') Rubberised finish and scrape bar protection on netting for long life Pole is lightweight (yet incredibly strong) - so more comfortable in use.



Image shows standard VariNet pole vs VariNet HD pole. The difference in girth is easily evident plus the HD poles come with a foam grip half way down the shaft for better grip.

Alongside the original 3m length telescopic pole there are new fixed length 1m and 0.4m poles.



### HD Skimmer Head

Due to unprecedented demand a Skimmer head is now available for attachment to the stronger net system - ideal for keeping big ponds in tip-top condition.

**Pro Pack** 3m Head Plus Catch, Sludge & Skimmer Head

**Our Price £59.96 Save £20**



Catch Net



Sludge Net

Model	RRP	OUR PRICE	DEAL PRICE
<b>Catching Net</b> 41cm x 46cm x 30cm LWD Large mesh	£39.99	£19.99	£34.99
<b>Sludge Net</b> 41cm x 46cm x 20cm LWD Medium mesh	£39.99	£19.99	£34.99
<b>Skimmer Net</b> 53cm x 25cm x 10cm LWD Fine mesh	£39.99	£19.99	£34.99
<b>Koi Sock</b> (Waterproof OR permeable)	£39.99	£19.99	£34.99
<b>Koi Pan Small</b> 60cm diameter, Fine mesh	£53.99	£26.99	£41.99
<b>Koi Pan Large</b> 75cm diameter, Fine mesh	£59.99	£29.99	£44.99
<b>HD Telescopic Pole 3m (10')</b>	£49.99	£24.99	
<b>HD Fixed Length Pole 40cm</b>	£19.99	£9.99	
<b>HD Fixed Length Pole 100cm</b>	£29.99	£14.99	

### Koi Socks

90cm long waterproof material plus 29cm long mesh part at the end. Flexible end part means it can be twisted round the wrist to cut off water flow when pinched.

Also available Net only version. Reduces lifting weight.

### Koi Pan Nets

Japanese style pan net heads provide a wide shallow surface - nice and safe when netting your fish. Two sizes.



## PondXpert VariNet - Interchangeable Head Hand Net System

*The right net for every job!*

6 different heads and a choice of 3 different length poles/handles.

Every pond is different! Choose the pond net right for you and add additional net-heads as you need them.

Note: VariNet & VariNet HD are different systems. Poles/heads can not be mixed between systems.



1 Pentagon 30cm

2 Algae Net

3 Sludge Net

4 Pentagon 40cm

5 Blanket Weed Brush

6 Light 'n' Easy Skimmer

7 Standard Skimmer

Premium Skimmer Head affixes at 45° meaning debris can be scooped with a 'golf club' style approach.

Flat net with fine mesh. Handy for picking up small debris from pond surface

Choice of three handle/pole lengths



- 1 Pentagon Fish Net Head 30cm (30cm deep) Large mesh **£8.99**
- 2 Algae Net Head 40cm (5cm deep) Very fine mesh **£8.99**
- 3 Sludge Net Head 40cm (18cm deep) Medium mesh **£9.99**
- 4 Pentagon Fish Net Head 40cm (30cm deep) Large mesh **£9.99**
- 5 Blanket Weed Brush Net Head Tough brush **£6.99**
- 6 Light n' Easy Skimmer Head Very fine mesh **£12.99**
- 7 Standard Skimmer Very fine mesh **£8.99**

- Fixed Handle 1.2m (4') **£6.99**
- Telescopic pole 1.5m (5') **£7.99**
- Telescopic pole 1.8m (6') **£9.99**



**- Special Offer -**  
Blanketweed Head + 1.8m Pole **£14.99**  
(Save £1.99)

# Pond Cleaning Tools

## PondXpert Skimmster

Bargain skimmer ideal for small ponds up to 25 square metres (16x16ft) surface area.

- 45watts.
- 2500lph integrated pump
- 10m power cable.

Sale Price **£69.99**

SAVE **£10**



pondXpert



## Velda Duo - Pond Scissors & Grabber

Clever six foot long (180cm) tool to prune pond landscape and pick up debris.

RRP £47.79 **Our Price 39.99**



## PondXpert Collapsible Pond Nets

Quality nets - essential pieces of pondkeeping kit. The telescopic collapsible nets are perfect for landing fishing, hooking objects out of the pond and skimming off debris. Extra-Long Reach (max Length 2.2m).

- 1 Pondxpert Collapsible Skimmer Net RRP £39.99 **Our Price £19.99**
- 2 Pondxpert Collapsible Landing Net RRP £39.99 **Our Price £19.99**



Fold down for easy storage

## PondXpert Pond Maintenance Set

Kit includes a sturdy telescopic aluminium pole and three interchangeable heads. The pole extends up to 1.8m (6') yet the whole kit fits into a small box for easy storage/transportation. The tools simply screw onto the end of the pole and include:

- 40cm/ 16" catching net
- 35cm/ 14" round skimming net
- Sturdy pond brush to keep waterfalls and pond edge clean

Sale Price **£29.99** SAVE **£5**



SUMMER SALE



## PondXpert Blanket Weed Algae Brush

Includes super-compact 1.8m pole and brush head. Perfect for pulling out string algae from your pond using a 'twirling' motion. Adjust from 0.6m (2ft) to 1.8m (6ft). Pole can also fit the full range of PondXpert VariNets (pg 67)



NEW

RRP £29.99  
Usually £19.99  
Sale Price **£9.99**

SUMMER SALE

## NEW PondXpert Treatments

- Anti-Green Water 2500ml **£29.99**
- Anti-Duckweed BIO-ACTIVE 250ml **£9.99**
- Anti-Duckweed BIO-ACTIVE 2500ml **£34.99**



NEW

Super-Size  
2.5 Ltr

Save  
£££'s

## Pond Liner Brush

This stiff adjustable brush with quality alloy handle is ideal for brushing off any algae that may collect on the exposed sides of your pond liner.

Length 1.7m.

RRP £37.99  
**Our Price £32.99**



## PondXpert Pond Gloves

New improved shoulder length pond gloves. Extra-long gauntlet offers top protection. One size fits all.

RRP £29.99 Was £14.99  
**Sale Price £9.99**



## Hozelock Pond Grabber

Handy cleaning tool for grabbing items that have fallen out of reach into your pond.

- Simple trigger (with lock) mechanism
- Magnetic! Can Retrieve light metal items
- Twist and lock feature which allows the grabber head to be used vertically or horizontally
- Total length of 90cm
- Rubberised grabber pads, protects liner from harm
- Rubber comfort grip

RRP £23.69 **Our Price £19.99**



## Hozelock BlanketWeed Brush

Super value cleaning tool. The Hozelock Telescopic Blanket Weed Brush is a very simple and effective way to manually remove unsightly blanket weed from the pond. It has a durable nylon brush head and high quality telescopic handle which extends from 0.6m (2ft) to 1.8m. (6ft).

RRP £26.79 **Our Price £22.99**

# Pond Netting

## PondXpert Pond Cover Net

Hard-wearing nets designed to cover the pond surface and protect from fallen leaves and other debris. Also protects fish from predators. Packs include pegs for secure installation.

Mesh size 12mm(1/2").

- 3 x 2m RRP £15.99 **Our price £7.99**
- 4 x 3m RRP £29.99 **Our price £14.99**
- 6 x 4m RRP £45.99 **Our price £22.99**
- 10 x 6m RRP £73.99 **Our price £36.99**



## Velda Premium Cover Net

*Buy Once - Use Again & Again & . . .*

**Premium pond cover net** - the best we have seen!

This finely-woven and durable cover net is very effective in keeping leaves and debris out of your pond in the autumn and will keep herons and other intruders at bay all through the year.

- Premium Net 3 x 2m** RRP £19.99 **Our price £16.99**
- Premium Net 4 x 3m** RRP £31.79 **Our price £24.99**
- Premium Net 6 x 5m** RRP £57.69 **Our price £49.99**
- Premium Net 10x 6m** RRP £99.99 **Our price £79.99**

3 x 2m, 10 pegs, 4 x 3m, 14 pegs  
6 x 5m, 22 pegs, 10x 6m, 32 pegs



Very finely woven - 1cm square mesh catches small debris.



Reinforced edge all around Strong holding rings



Strong metal pegs keep net in position



Zip bag for storage

## Blagdon Pond Cover Nets

Fine black mesh nets designed to be pitched across pond surface to prevent debris such as falling leaves dropping into pond. Can also be used to deter predators such as herons.

*Nets come with fixing pegs supplied.*

Size	RRP	OUR PRICE
3x2m	£12.99	<b>£10.99</b>
4x3m	£22.49	<b>£18.99</b>
6x3m	£30.99	<b>£25.99</b>
6x4m	£38.49	<b>£31.49</b>
6x5m	£44.99	<b>£37.49</b>
10x6m	£72.99	<b>£59.99</b>



## PondXpert Swap Net Set

Keep your pond in tip-top condition with this pond maintenance set.

Set contains:

- A sturdy telescopic pole extends to 6 feet (1.8m)
- 30cm Skimmer Net head for skimming out fine debris and waste off the pond surface
- Tough Brush Head for scrubbing waterfalls and liner sides. Handy for lifting out blanket weed using a 'twirling' action too

Was £29.99 **Now £22.49**

Pole fits onto VariNet net heads. See pg 67.



**SUMMER SALE**

# Pond Vacuums - Manual/Water Pressure Pond Vacuums

## PondXpert Telescopic Pond Silt Remover

*Hand Operated*

A simple, easy to use hand operated pump device for removing silt from the bottom of the pond.

Every pond accumulates a layer of silt and debris in the bottom of their pond no matter how hard you try to keep it clear. This can lead to problems with water clarity, pollution of the water etc and therefore should be removed frequently.

This silt vac is the ideal solution - lightweight and not powered by electricity, it can be taken to the pond, used to hand pump out the silt and stored ready for next use.

*Every pond keeper should have one!*

**Features:**

- Easy to use
- Telescopic - extends to 2 metres (6' 7")
- Also removes floating debris
- Complete with strainer bag
- Simple 'bicycle pump' action

**Silt Remover**

Was £49.99 **Now £39.99**



**SUMMER SALE**

# Pond Vacuums

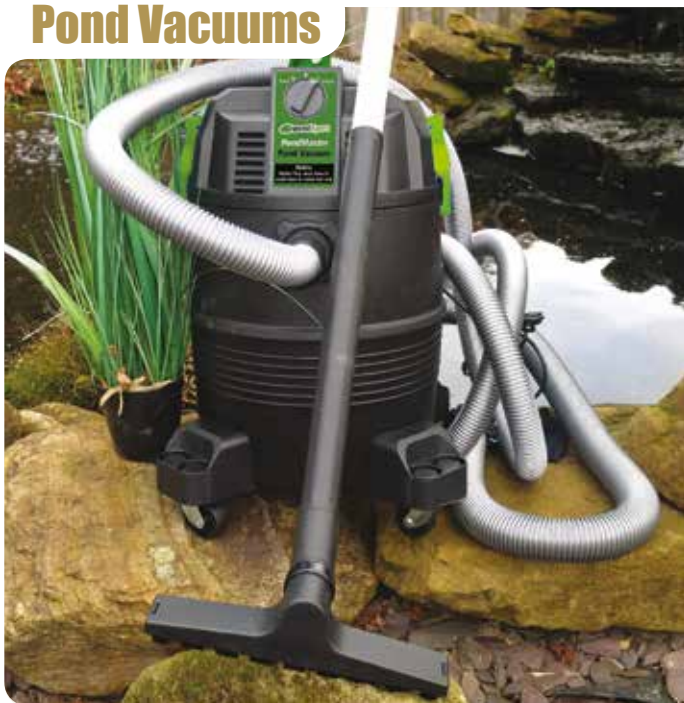

## PondXpert PondMaster

We're delighted to be able to offer to you the best value pond vac we have ever seen.

Despite the low price this vac offers better features than all other budget pond vacuums on the market.

- Use Indoor or Out
- Extra Powerful 1400 Watts
- Large 35 Litre Chamber
- Auto-Empty when full
- Max. Operating Depth 2m
- 2 Year Guarantee
- Four Swivel Wheels
- Three Head Nozzels

RRP £239.99

**Our Price £119.99**

Add a Discharge Basket for **£20**

**Combo Deal £139.99**



## PondXpert Pond Vac Discharge Basket

This handy filtration unit extracts solid particles from vacuumed pond water allowing clean water to return to the pond.

- Collapsible for easy storage
- Designed for use with pondmaster but can be used with all vacs

**Discharge Basket** RRP £89.99 **£44.99**

**Basket Outlet Extension Hose 1m** RRP £49.99 **£24.99**

**PondXpert Pondmaster Vac + Basket** **£139.99** Save **£24.99**



## "Chamber" Style - Pond Vacuum Accessories

### Discharge Collection Bag

Fine mesh discharge collection bag with locking mechanism for a tight fit.

**Our Price £4.99**



### Replacement sponge Collar

Chamber vacs (Oase, Cleanopond & PondMaster) require the use of a sponge 'collar' to protect from particles.

**Our Price £9.99**



### Pond Vac Indoor Bags

Replacement paper bags. Suitable for Cleanopond, Pondovac Start/Classic & PondMaster Vacs.

**Pack of three £5.99**

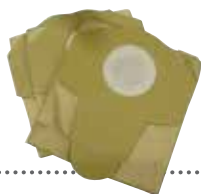

**Price Breakthrough**  
Usual price for this style of vac is over **£750**



- Quicker Cleaning
- Exit water can be pumped uphill
- Save £££'s versus competitor vacs



**EXCLUSIVE**

## PondXpert Non-Stop Vac

Professional pond vacuum with integrated discharge pump. Continuous operation reduces time taken to clean a pond.

RRP £499.99

**Our Price £249.99**



- Large 35 litre capacity
- Quality steel chamber
- 1200W Suction motor
- 600W Discharge pump
- Max Flow 11500LPH
- Max pump height 7m
- 4m suction hose
- 4 x suction extension pieces (2 clear)
- 4m power cable
- 2m discharge hose
- Internal discharge bag (leaves/large particles)
- External discharge bag (fine particles)
- 4 x wheels
- 2 Year Guarantee

## Non-Stop PRO Vac

Introducing a new heavy duty version of this bestselling vac. Non-Stop Pro has same core features of the original Non-Stop plus:

- Better discharge pump with 35mm solids handling
- Extended three year warranty
- 12m Discharge Hose (original 2m + 2x5m extension).

Pro version pump specification:  
12000 LPH, 6m max height, 500W

RRP £599.99 Was £299.99 **Now £279.99**



## Non-Stop Outlet Hose Extension 5m

RRP £59.99

**Our Price £29.99**



# Pond Vacuums

## SludgeMuncher Pond Vacuum

A lightweight vacuum that is easy to manoeuvre. Whisper quiet compared to other vacs and only 80watts to run.

- 3m waste hose
- Extendable handle up to 2m (6'6")
- Easy 'in-pond' visibility

RRP £199.99 **Our Price £99.99**

## SludgeMuncher Dirt Basket

Collapsible basket can be used to collect dirt & debris. (note: must be positioned lower than vac to work).

RRP £89.99 **Our Price £44.99**



**Vac & Basket COMBO DEAL**  
**£119.99**  
**Save £25**



★★★★★  
**94%**  
 26  
 Customer reviews

## Vac Wheel Set

*"Wheely" Good Upgrade*

A set of 4 wheels can be purchased to make for easier manoeuvring.

RRP £49.99 **Our Price £24.99**



# Pond Vacuums

★★★★★  
**80%**  
 10  
 Customer reviews



## Hozelock Pond Vacuum

A lightweight vacuum that is easy to manoeuvre. Whisper quiet compared to other vacs and only 80watts to run.

- 3m waste hose
- Extendable handle up to 2m (6'6")
- Easy 'in-pond' visibility

RRP £274.99 **Our Price £139.99**



**FREE Discharge Bag worth £4.99**

## Hozelock Waste Basket

Catch the dirt from your Hozelock Vacuum with this collection basket. Can be used pondside so cleansed pond water can be returned to your pond.

RRP £69.99

**Our Price £59.99**

★★★★★  
**100%**  
 9  
 Customer reviews



## Hozelock Vac & Basket Offer

**Our Price £159.99 Save £29.99**

\*Free Basket is PondXpert brand



### Filbert Frog's Top Tip

Your existing pond water - though sometimes dirty looking - contains healthy bacteria that keeps your pond in balance. Use of a filter basket enables pond water conservation.

## Waterfall Spillways

*The pumps on this page are ideal for running a waterfall.*

To get the most impressive results from a waterfall we strongly recommend using a spillway.

This is positioned at the waterfall outlet and ensures a natural wider 'spread' of water than from hose alone.

This makes the water flow far more realistic to nature's own creations.

**Superfish Waterfall Spillway 19cm 20, 25mm £29.99**

**Superfish Waterfall Spillway 44cm 25, 40mm £89.99**

Both Waterfalls ship complete with filter media included.

Units can be used as rudimentary pond filters as well as spillways.

**Small Fall:** 25x20x25cm, **Large Fall:** 35x42x25cm (LWH)



★★★★★  
**100%**  
 3  
 Customer reviews

**LIMITED STOCK**

★★★★★  
**100%**  
 10  
 Customer reviews

# Pond Ultraviolet Clarifiers (UVCs)

## Blagdon Pro UVC

High quality UVC with big ponds in mind - power outputs range from 18 watts to 72 watts.

Multi-hosetails (20-40mm) and solvent weld 1 1/2" pipework adaptors included.

- 2 year guarantee
- Power cable length 5m



Model	Watts	Max Flow	Max Pond	Sale Price	SAVE
Pro 16200	18	8100	16200	£121.49	£13.50
Pro 21600	24	10800	21600	£139.49	£15.50
Pro 32400	36	16200	32400	£146.69	£16.30
Pro 64800	72	32400	64800	£251.99	£28

Max pond figures are for a shaded, deep pond. A sunny / shallow pond will require extra power than quoted:

Sunny 25%  
Under 75cm depth 25%  
Koi 50%  
8-10 watts per 1000 gall/ 4500 Ltrs.



## Evolution Aqua Evo UVC

The evo range has been completely redesigned to be able to now claim the position of most robust and technologically advanced uv unit on the market.

- IPX5 IP rating
- Can be used with flexible or hard pipe connections
- Ballast located in a fully water tight cover.
- Supplied with 2 x 38mm (1 1/2") hosetails



Model	Watts	Length (mm)	Max Flow	Max Pond	RRP	OUR PRICE
evo15	15	580	7500	15000	£124.95	£119.95
evo25	25	580	10000	20000	£129.95	£124.95
evo30	30	980	15000	30000	£184.95	£174.95
evo55	55	980	20000	55000	£219.95	£199.95
evo75	75	1280	25000	75000	£249.95	£229.95
evo110	2 x 55	1060	25000	75000	£299.95	£274.95



### Fibbert Frog's Top Tip

Quartz Sleeves can be cleaned using distilled (white) vinegar.

Simply cover quartz with kitchen roll, drench in vinegar then leave for 2 hours or so depending on quartz condition.



# Pond Ultraviolet Clarifiers (UVCs)

## Ultra Violet Clarifier

### What is an Ultra Violet Clarifier?

A UVC consists of a chamber holding an electrical lamp behind quartz glass. Water is pumped through this chamber to prevent pond water turning green.

### How Does It Work?

Pond water is subjected to high levels of U.V light. This U.V. light causes the microscopic single cell algae to be clumped together allowing them to be collected and broken down by the biological filter.

### Before UVC

Typical "pea soup" colour.



### After UVC

Clear water lets you see what is happening below the waterline.



Don't miss **NEW Solar Powered UV** on pg 46

## PondXpert Greenstop UVC

New UVC from PondXpert offers incredible value for money. All come with a set of hosetails to take 20/25/32/40mm hose. 1 year guarantee. **Complete with 8.5m power cable.**



Model	Watts	Max Flow	Max Pond	RRP	OUR PRICE
Greenstop 9000	11	4500	9000	£139.99	£69.99
Greenstop 15000	18	7500	15000	£179.99	£89.99
Greenstop 23000	36	10000	23000	£219.99	£109.99
Greenstop 40000	55	20000	40000	£279.99	£139.99

## PondXpert Greenstop Pro

Premium UVC with turbulator. Pro 36 designed to fit snugly onto PondXpert MultiChamber & Oase Biotec filters.

Model	Watts	Max Flow	Max Pond	RRP	OUR PRICE
Greenstop 36 Pro	36	10000	23000	£299.99	£149.99
Greenstop 55 Pro	55	5000	40000	£359.99	£179.99
Greenstop 72 Pro	72	6000	60000	£439.99	£219.99



## Hozelock Vorton UVC

Our bestselling range of UVC's just got better with three new models added. All models come complete with bulb and 5m electrical cable.



Model	Watts	Rec Flow	Max Pond	Sale Price	SAVE
Vorton 11	11	2000	4000	£69.99	£40
Vorton 18	18	Range discontinued			
Vorton 36	36	by manufacturer			
Vorton 55	55	Only 11W left in stock.			



### Fibbert Frog's Top Tip

The bulb wattage should always be shown on the bulb end.



# Pond Ultraviolet Clarifiers (UVCs)

## Evolution Aqua Titanium UVC 55W & 110W



Evolution Aqua Titanium UVC 55W

The Evolution Aqua Evo Titanium UV Clarifiers are made using the latest technology and are lined with a thick and polished titanium tube, to clear green pond water fast.

When the UV light strikes the internal surface of the titanium chamber it produces an instant photocatalytic reaction and generates Hydroxyl Radicals, a powerful oxidant, that

instantly destroys organic and inorganic matters, neutralising water-born algae, bacteria and viruses resulting in clearer water whilst being perfectly safe for all pond life.

Model	Watts	Max Flow	Max Pond	RRP	OUR PRICE
Titanium UVC 55W	55	20000	40000	£274.99	£249.99
Titanium UVC 110W	110	25000	50000	£374.99	£349.99

*Clears green water faster - Up to 1.5 times more effective than a standard UV*



Evolution Aqua Titanium UVC 110W

Evolution Aqua Titanium UVC 110W (cut-away view)

- Easy and cost effective to maintain - Removable, fully serviceable, showerproof control box.
- Choice of connections - Connect to rigid pipe or use hose tails to connect to flexible hose.
- Mounting brackets included.

55 watt Titanium UV Clarifier is suitable for ponds up to 55,000 litres (12,100 gallons) with an optimum flow rate of 15,000 litres per hour (3,300 gph).  
The maximum flow rate is 20,000 lph (4,400 gph)

110 watt Titanium UV Clarifier is suitable for ponds up to 75,000 litres (16,500 gallons), with an optimum flow rate of 20,000 litres per hour (4,400 gph).  
The maximum flow rate is 25,000 lph (5,500 gph).

**NEW**

# UVC Bulbs & Spares

## UVC Quartz Sleeves

All UVC bulbs sit inside a watertight glass/quartz chamber that can get dirty over time. Quartz sleeves can be cleaned but we carry a comprehensive list of spares if required.

EasyClear 3000	£29.99	Vortron 55	£49.99	Bioforce R 9000	£39.99	EasyFilter 30000	£24.99
EasyClear 6000	£29.99	Greenstop 9000	£19.99	Bioforce R 14000	£49.99	Filtobox 6000	£19.99
EasyClear 9000	£34.99	Greenstop 15000	£19.99	SpinClean 6000	£19.99	Filtobox 12000	£24.99
TripleAction 3/4000	£19.99	Greenstop 23000	£24.99	EasyFilter 4500	£14.99		
Vortron 11	£35.99	Greenstop 40000	£24.99	EasyFilter 9000	£19.99		
Vortron 18	£39.99	Greenstop 36 Pro	£29.99	EasyFilter 12000	£24.99		
Vortron 36	£44.99	Bioforce R 6000	£34.99	EasyFilter 20000	£24.99		

Bulb	Bulb Type	OUR PRICE	Example Filter that Bulb fits
4W	Double ended - single tube	£6.99	Green Genie 2
5W	Single ended (Pls type)	£9.99	EasyClear 3 Bioforce 3
6W	Double ended - single tube	£7.99	G2C 3, Ecopower 2.5
7W	Single ended (Pls type)	£12.99	EasyFilter 4.5, Bermuda 4, Filtral 3
8W	Double ended - single tube	£8.99	G2C 6, TMC8, Ecopower 5, Green Genie 3
9W	Single ended (Pls type)	£13.99	EasyClear 6, Bioforce 5.5, Filtoclear 3, EasyFilter 9
11W	Single ended (Pls type)	£16.99	Bioforce 8, Filtoclear 6/11/15, Filtral 9, EasyFilter 12
13W	Single ended (Pls type)	£14.99	EasyClear 9000, Bioforce 12000 (mid 2012 on)
13W	Single ended (Pls type)	£13.99	GX Base Double Fin Bioforce 12 (pre-2012), Fishmate 15
15W	Single ended (Pls type)	£10.99	Fmate Gravity 15/30, TMC 15
16W	Double ended - single tube	£12.99	G2C 12, Ecopower 10, Green Genie 6 & 12
18W	Double ended - single tube	£14.99	G2C 18, Clear Pond 18
18W	Single ended (Pls type) 4 pin	£14.99	Filtomatic, Bitron 18, Midipond18, EasyFilter 20
24W	Single ended (Pls type) 4 pin	£24.99	Midipond14, Fmate 30, EasyFilter 24
25W	Double ended - single tube	£13.99	G2C 24/30/48, Clear Pond 25 & 50, Green Genie 24 & 48
30W	Double ended - single tube	£15.99	TMC30
36W	Single ended (Pls type) 4 pin	£19.99	Fmate 45, Bitron 36/72
40W	Double ended - single tube	£19.99	Clear Pond 80
55W	Double ended - single tube	£19.99	TMC55, Lotus 55 UVC
55W	Single ended (Pls type)	£24.99	Bitron 55/110
75W	Double ended - single tube	£22.99	Lotus 75 UVC
100W	Double ended - single tube	£24.99	Lotus 100 UVC
11W	Single ended 4 pins	£14.99	Laguna pressure-Flo 2.5/5
20W	Single ended 4 pins	£17.99	Laguna pressure-Flo 8
25W	Single ended 4 pinse	£19.99	Laguna pressure-Flo 12

**SUMMER SALE**

*UV radiation power decreases over time. Bulbs should be replaced annually - preferably in spring.*

**Buy One get one FREE**

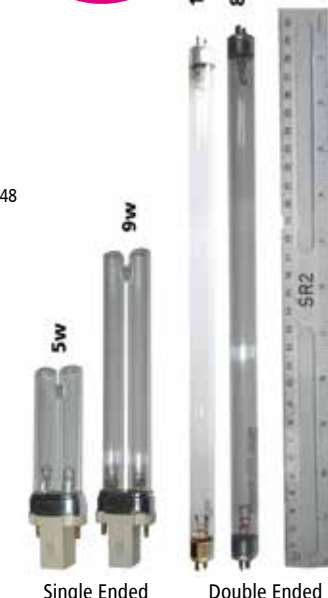



# Outdoor Power Management

The use of weatherproof outdoor switchboxes mean you just need one cable to your mains supply and you can control your equipment pondside. Any lengths of exposed outdoor cable should be housed in a metal sheath to prevent accidental breakage.

## PondXpert Outdoor Switchboxes

Outdoor switchboxes are essential pondkeeping kit. These sturdy switchboxes offer a number of outlet options and are easy to wire up.

Max load per outlet 400 watts.

Max load per 'box (1200W/1600W/2400W for 3/4/6 Way respectively). Inlet accepts standard outdoor cable.

**3-way** RRP £69.99 Was £34.99 **Sale Price £29.99**

**4-way** RRP £79.99 Was £39.99 **Sale Price £34.99**

**6-way** RRP £109.99 Was £54.99 **Sale Price £49.99**

**3-way for Armoured** RRP £109.99 **Our Price £54.99**

**SUMMER SALE**



**IMPROVED**

larger terminal blocks for easier wiring and 3 year guarantee.



**Powersafe Switch Box**  
Allows connection of up to 5 electrical cables from one standard mains cable. Easy installation and outlet is individually fused - if one blows the others continue. Max load is 1000w for first outlet and 300w for remainder.

## Powersafe Switch Box

Allows connection of up to 5 electrical cables from one standard mains cable. Easy installation and outlet is individually fused - if one blows the others continue. Max load is 1000w for first outlet and 300w for remainder.

**2 Way** RRP £56.49 **Our Price £41.99**

**3 Way** RRP £67.99 **Our Price £49.99**

**4 Way** RRP £88.99 **Our Price £64.99**

**5 Way** RRP £112.99 **Our Price £79.99**

## PondXpert Electrical Cable Connector

Joins electrical cable with a watertight seal but has the benefit of being able to 'snap off' the connection.

This means that outdoor items such as pond pumps can be easily disconnected and removed when necessary (eg, winter).

**No cap is available on this new model.**

RRP £39.99 **Our Price £19.99**



## Power Breaker RCD

Added safety. Designed specifically for water gardening. Great for pond vacuums.

RRP £19.99 **Our Price £14.99**



## PondXpert Electrical Cable Joiner

Waterproof connector - perfect for extending power cable length.

**1 Joiner 3 Way** RRP £29.99 **Our Price £14.99**

**2 Joiner** RRP £25.99 **Our Price £12.99**



## Armoured Cable

**£4.00** per metre

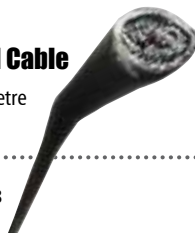

## Outdoor Cable

**£1.50** per metre



# Air Pumps



Adding oxygen to a fishpond is very important to fish health. This is particularly true in summer months and if the pond is heavily stocked. But even in ponds without fish an air pump will help keep the water fresh - particularly if a waterfall or fountain is not present.

## What Size of Pump for my pond?

We have included a table (right) as a buying guide. Many pondkeepers do not keep fish in the pond and here addition of a smaller air pump will be sufficient. Fish ponds require a larger amount of air, koi ponds especially. If keeping other 'oxygen hungry' species such as sturgeon then the flow suggested above should be amplified further. Indeed please treat this as advice as a guide only - every pond is different. Remember oxygen can be gained from pond plants, fountains and waterfalls too!

**NOTE:** Remember the higher the water temperature the less dissolved oxygen the water can hold.

Air Pump Sizing Guide			
Air LPH	Pond Volume (Litres)		
Output	No Fish	Fish	Koi
210	1500	1100	500
450	3000	2500	1200
600	4250	3300	1650
1200	8500	6600	3300
1800	12750	10000	5000
2400	17000	13200	6600
3600	25500	20000	10000
4800	34000	26400	13200
6000	43200	33000	16500

## PondXpert ElectroAir Pond Air Pumps

We're proud to be able to bring to you these sturdy professional air-pumps at a highly competitive price. All pumps have been manufactured with a heavy metal outer casing to add ballast which reduces noise in operation.

Fully weatherproof with 2m (7 feet) power cable.

Model	Max Air Output	RRP	Watts	OUR PRICE	Price Inc. Air Kit
2100	2100 lph	£219.99	20	<b>£109.99</b>	<b>£122.98</b>
2700	2700 lph	£239.99	25	<b>£119.99</b>	<b>£132.98</b>
3600	3600 lph	£259.99	38	<b>£129.99</b>	<b>£142.98</b>
4800	4800 lph	£329.99	55	<b>£164.99</b>	<b>£177.98</b>
6000	6000 lph	£359.99	65	<b>£179.99</b>	<b>£192.98</b>



## Half-Price Accessories Kit

Accessories Kit contains (A) a six-tap chrome manifold, (B) four large 50mm airstones and (C) 25 metres of 4mm clear airline.

Usual selling price £26.94 **Our Price £24.99**  
**Promotional Price Only £12.99** when purchased with any ElectroAir Pump

## Perfect Partner for ElectroAir Pumps



## ElectroAir Air Pump Accessories

All ElectroAir and ElectroAir Compact pumps come complete with 4mm outlets. We now stock a full range of accessories based on this 4mm fitting (This is the most popular size and these products will fit any other brands using the size of outlet).

- (A) ElectroAir 15cm Plate Air Stone **£9.99**
- (B) ElectroAir 13cm Heavy Air Stone **£2.99**
- (C) ElectroAir Chrome Manifold 6 way **£8.99**
- (D) ElectroAir Airline 4mm x 100m Clear **£29.99**
- (E) ElectroAir Clear 4mm Airline x 25m **£9.99**
- (F) ElectroAir 2"/50mm Air Stone Blue **£0.99**
- (G) ElectroAir 2"/50mm Air Stone Sintered Grey **£1.99**
- (H) ElectroAir 4mm Check Valve **£0.49**



**EA Black Sinking Hose** for maximum disguise. 4mm. **£2.99** per metre

## PondXpert Black Sinking Airline 25m

Black weighted airline (4mm internal diameter). Makes for a tidier pond appearance for a super low price.

RRP £59.99 Was £29.99 **NOW £24.99**

PondXpert Clear Airline and new Weighted Black Airline running attached to the same air pump in one of our own ponds (Feb 2020). **The difference is striking!**



Standard Airline can look unsightly



Black Airline is more discreet around the pondside.

## Air Pumps

### PondXpert ElectroAir Compact

Weatherproof air pumps designed for outdoor use. Durable pumps with polymer composite rubber air chamber held under aluminium casing.

- Quiet Operation
- Efficient Eco motor with low energy use
- Robust Design
- Includes all fittings to get you started
- Includes 2m (7') power cable.



**SUMMER SALE**

210 & 450 Different Design  
\* 210 & 450 simple fittings only - see listing below



### Pondkeeper Recommended product

Quality fittings including chrome manifold \*

Model	Max Flow Rate (per hr)	Power	Air Stones	Air Tubes	Manifest	RRP	OUR PRICE
EA Compact 210	210	3.3 Watts	2	2x5m	N/A	£49.99	<del>£24.99</del> <b>£22.99</b>
EA Compact 450	450	6 Watts	2	2x5m	N/A	£69.99	<del>£34.99</del> <b>£29.99</b>
EA Compact 600	600	10 Watts	2	2x5m	2 - way	£119.99	<del>£59.99</del> <b>£49.99</b>
EA Compact 1200	1200	15 Watts	2	2x5m	2 - way	£149.99	<b>£74.99</b>
EA Compact 1800	1800	25 Watts	4	4x5m	4 - way	£179.99	<b>£89.99</b>
EA Compact 2400	2400	30 Watts	4	4x5m	4 - way	£219.99	<b>£109.99</b>
EA Compact 3600	3600	35 Watts	8	8x5m	8 - way	£279.99	<b>£139.99</b>

### Hozelock Air Pump Range

Stylish, reliable weatherproof range of air pumps. There is a comprehensive range to suit most ponds. All are fully weatherproof so can be left outside. 3m long power cables with 320 & 640, 10m with others.

**SUMMER SALE**



Model	Air Flow ltrs	Max Depth	Air Stones	Air Tube	Watts	Power Cable	RRP	Was	SALE PRICE
Hozelock 320	320 per hr	1.2m	2	10m	4	3m	£66.99	£47.99	<b>£39.99</b>
Hozelock 640	640 per hr	1.2m	4	10m	8	3m	£103.99	£76.99	<b>£66.99</b>
Hozelock 1500	1500 per hr	2.0m	2	20m	17	10m	£179.99	£134.99	<b>£119.99</b>
Hozelock 2700	2700 per hr	2.0m	2	20m	35	10m	£244.99	£189.99	<b>£174.99</b>
Hozelock 4500	4500 per hr	3.0m	2	20m	35	10m	£276.99	£214.99	<b>£199.99</b>

# Solar Air Pumps

## PondXpert SolarAir 100

Max Air Output 100lph, one airstone, 1m airline, 1W Panel.

RRP £69.99

Was £34.99

**Sale Price £24.99**



Save £10

Entry-Level work in direct sun only

SUMMER SALE



## PondXpert SolarAir 200

Max Air Output 200lph, one airstone, 1m airline, 1.4W Panel.

RRP £89.99 Was £44.99 **Sale Price £34.99**



Save £10

SUMMER SALE

## PondXpert SolarAir Float

Air pump designed to float on the surface of your pond (or can be moored pondside).

- Maximum air Output 150lph
- 0.8W solar panel
- 0.5m airline with single airstone

RRP £79.99 Was £39.99 **Sale Price £29.99**



Save £10

# Accessories

## PondXpert SolarAir 200 PLUS Mains Adaptor Set

Use this new 6.3V mains adaptor to charge up the battery-pack supplied with the unit. Set includes an adaptor to fully charge the battery and a transformer cable so unit can be powered directly from the mains. Set is not weatherproof - charging must be indoors or a dry area. Enables air-pump to be used indoors (eg, for an aquarium).

RRP £25.99 **Our Price £12.99**

All adaptor & transformer cables **NOT** weatherproof



## PondXpert Replacement Airstones

Airstones will wear out over time - don't worry as we have the replacement airstones suitable for all PondXpert models.

RRP £1.99 **Our Price £0.99**



**SolarAir 150 Plus** has the pump motor and battery fixed to the back of the solar panel.



**Filibert Frog's Top Tip**  
Great space saver!



# Solar Air Pumps with battery back-up

## Premium Oxygenators that work day AND night

Save £10

## PondXpert SolarAir Float Battery

Air pump designed to float on the surface of your pond (or can be moored pondside).

- Maximum air Output 150lph
- 0.8W solar panel
- 0.5m airline with single airstone

RRP £99.99 Was £49.99 **Sale Price £39.99**



SUMMER SALE

## PondXpert SolarAir 150 PLUS

Solar air Pump with Lithium battery. Pump integrated into panel to save space.

Max Air Output 150lph, one airstone, 1m airline. Quality Lithium battery. 1 Watt solar panel.

RRP £99.99 Was £49.99 **Sale Price £39.99**

Save £10



SUMMER SALE

## PondXpert SolarAir 200 PLUS

Solar air Pump with Nimh AA battery. Twin airstone. Battery can be charged by mains adaptor (available separately).

Max Air Output 200lph, two airstones, 2m airline. 1.5 Watt solar panel.

RRP £119.99 Was £59.99 **Sale Price £49.99**



Save £10

## SolarAir 300 Battery+

Introducing the most powerful solar air pump in our range. Includes high storage lithium battery and features three operating modes - Continuous, Intermittent and Gradient.

NEW



Save £10



Premium 38mm AirStone discs

- Charge by solar panel or USB connection indoors (USB cable included)
- Power: 3.5 Watts
- Battery: 3.7v/4000mAh
- Output: 300 LPH
- Set includes 2 airstones, airline (1.2m x 2), two check valves
- Quiet operation
- Great for indoor fish tanks as well as ponds
- 2 Year Guarantee

RRP £139.99 Was £69.99 **Sale Price £59.99**

# Pond Deterrents

Isn't it time to scare away those pesky herons for good?

## Velda Laser Guard

Herons are one of the hardest creatures to scare away but Velda of Holland are determined to find the answer!

The latest motion-activated deterrent utilises laser lighting, strobe effect and three different degrees of sound.

**Our Price £199.99**



## Velda Bird Blocker Band

Reflective ribbon with ground pegs to scare away birds.

**Our Price £14.99**



## Pond Protector - Harmless electric fence

Efficient method to keep herons and cats away from a pond. The transformer gives off a low voltage electric pulse to the fence round the pond. This shocks herons or cats and persuades them to try elsewhere. Inclusive of transformer, 10 synthetic rods, 80m of electric fence, connectors and instructions. The electric cable has a length of 80m, which is sufficient to protect 40 metres of pond side with two cables. Extension set provides an additional 40m coverage.

**Pond Electric Fence** Was £99.99 **Now £69.99**

**Pond Electric Fence Extension Set** £39.99

**Protector + Extension** £89.99 **SAVE £19.99**



## Floating Pyramid

Floats on pond surface with reflective surface scaring off herons.

**Our Price £12.99**



## Jet Spray Protector

Attach device to your garden hose and water will spray when movement detected.

**Our Price £39.99**



## Velda Spinner

Spinning scarer moves in the wind. RRP £38.99 **Our Price £29.99**



## Velda Reflector

Floating mirrored sphere scarer. RRP £26.99 **Our Price £19.99**



## Replica Heron

Herons are territorial creatures so usually avoid each other. Place this realistic replica near your pond and it should help to stop the real thing.

RRP £49.99

**Sale Price £19.99**



**Save £5**



# Near Invisible Protection

**2 for 1 Offer £29.99**  
60 rings for the price of 30



**Interlocking Floating Ring Set**



## PondXpert Pond Protectors Floating Fish Protection System

Bestselling 'floating grid' protection system. Simply join the discs together to form a formidable barrier against unwanted herons.

**Get 60 Rings for every 30 purchased with our special offer.**

**PondXpert Pond Protectors 30** (30 rings, 96 clips)  
RRP £59.99 **Our Price £29.99**



**Sizing Guide:**  
10 rings protects 5 feet (1.52m) of shoreline

## Filter Media

**SUMMER SALE**

### PondXpert Filter Start Gel

Microbe packed gel that helps to mature filters quickly. 1 Litre treats 15,000L

**PondXpert Filter Start 1Ltr**  
RRP £39.99 **Our Price £19.99**



**Buy 1 Get 1 FREE**

### PondXpert Filter Media Bags

Mesh bag with drawstring that can be filled with your choice of filter media. Then filled bag can be placed in your filter chamber.

**Small Media Bag** (45x30cm)  
RRP £15.99 **Our Price £7.99**

**Large Media Bag** (60x45cm) RRP £19.99 **Our Price £9.99**



### PondXpert Zeolite 5 Ltrs

(Approx 8kg)

Reduce algae & ammonia issues. FREE Filter Mesh Bag included.

RRP £34.99 **Our Price £16.99**



## Velda (VT) Media 5 Ltrs (treat 3000L) **NEW**

### VT Filtra Sub Filter Media

Coarse structure helps remove coarse dirt particles. Perfect for the first stage of the filtration process.

RRP £19.99 **Our Price £15.99**



### VT Zeolite Filter Media

Zeolite is a natural stone which binds nitrates & phosphates. This helps keep ponds algae free. Also useful at reducing ammonia & nitrite issues.

RRP £27.50 **Our Price £22.99**



### VT Lava Rock Filter Media

Very porous rock - a natural material with many coarse pores. Ideal for the intermediate stage of filtration.

RRP £18.49 **Our Price £14.99**



### VT Carbon Filter Media

Activated carbon is highly effective at removing fine particles such as: fine dirt, aromatic substances & colourings. Use as a final stage of filtration.

RRP £33.29 **Our Price £24.99**



# Pond Treatments - Inline Dechlorinators

## In-Line Dechlorinators

As most fish-keepers know tap water is great for us humans but not so good for the fish we look after. Tap water contains chlorine and other impurities that are hazardous to fish.

It is therefore essential that these elements are removed from tap water before it is used to 'top-up' or fill a pond. An inline dechlorinator saves playing around with messy liquid treatments or waiting for chlorine to 'gas-off'.

Simply running tap water through one of these units ensures your water is pond-safe straight from the tap and one unit will be enough to decontaminate 200,000 litres of water - an amount that will take a typical Pondkeeper 2 years to get through.



### Evolution Aqua Detox Dechlorinator

Hi-grade activated carbon removes chlorine, chloramine, bromine, malachite green, dyes, colours, humic acids, organics, proteins, antibiotics, hormones and ozone.

Improved in 2017 with high capacity carbon for optimum chlorine removal. Recommended flow rate: 4 litres per min.

The 12 inch high-grade activated carbon filter will treat up to 225,000 Litres / 49,493 U.K. Gallons.

The 30 inch high-grade activated carbon filter will treat up to 550,000 Litres / 122,083 U.K. Gallons. Maximum treatable water is based on incoming 0.5ppm chlorine.

**12" Detox Dechlorinator In Line Filter Our Price £84.95**

**30" Detox Dechlorinator In Line Filter Our Price £124.95**

## PondXpert 10" In-Line Dechlorinator

New advanced dechlorination from PondXpert. This unit is packed with superior materials meaning increased capacity can be achieved from a unit with a smaller footprint. Contains a blend of Hi Grade carbon and Ceramet active ceramics. Ceramet ceramics are porous and have an extremely large surface area (500 times that of carbon) and have been used in Japan for many years to keep Koi ponds clear and the fish free of disease.

Premium 'Hi Grade' carbon is used as a drinking water treatment illustrating its trusted quality and effectiveness. Cartridge will treat up to 150,000 litres. Max recommended flow rate 9 litres per minute (the slower the flow rate - the more impurities are removed).

RRP £139.99 Was £69.99

**Sale Price £59.99**



# Pond Treatments - BlanketWeed Cures

**NEW**



## PondHero BlanketWeed Blaster - Solar Algae Remover

String algae or blanket weed can be a real problem in late spring/summer. This new solar ioniser from PondHero tackles the problem quickly and effectively.

Float the unit on your pond and sunlight activates release of copper ions into water. Copper ions bind themselves to pond contents preventing algae growth.

!!Excess copper ions are dangerous to pond life (see 'operating advice' below)!!

**SUMMER SALE**

### Benefits

- So easy! Simply floats on your pond surface
- Clears string algae quickly
- Releases copper ions to combat algae growth
- Works in sunny weather just when algae worst
- No messy wiring or running costs
- No need to cut into existing hose pipework

### Operating Advice

Not recommended for use in ponds with fish (can be used with careful monitoring). Use when pond water 12 degrees C or higher. Powerful & Effective - designed to be used for 'short blasts' in smaller ponds. Remove from action once weed is cleared.

### Spares Kit

RRP £79.99

**Our Price**

**£39.99**



### Replacement Copper Anode

RRP £49.99

**Our Price**

**£24.99**



## Hanna HI-747 Copper Checker

Ultra-fine digital tester. Recommended if Blaster used in fish ponds.

HC: 0 to 999 ppb, plus 6 tests

RRP £97.20 **Our Price £89.99**



### Specification

- Suitable for ponds up to 35,000 Litres volume
- Set contains Blaster unit, test strips & brush
- 2W Solar Power (6v)
- Also suitable for hot tubs and swimming pools

## PondHero BlanketWeed Blaster - Solar Ioniser

RRP £159.99 Was £79.99

**Sale Price £69.99**

**Save £10**

Anode depletes during use. But process is slow and anode should last multiple seasons



# Pond Treatments - BlanketWeed Cures



BlanketWeed is a long string algae that thrives in healthy ornamental ponds. Its growth is increased by bright sunlight and shallow fast running water so it will be found in water-falls and unshaded pond areas. Overstocked fish ponds can also contribute.

The simplest 'natural' treatment is to stock the pond with plants and animals that actively consume blanket weed or compete for the same food. Other highly successful methods include the careful use of copper ions, barley straw and pond vacuums.

## Barley Straw - The Traditional method used since the middle ages



Safe to use. Not affected by recent HSE recall

### PondXpert Barley Straw Essence

Effectively clears blanketweed and green water.

1000ml treats 22750Lts (5000 gal).

250ml **£8.99**  
1Litre **£19.99**



60% Extra Fill

### PondXpert 'Throw 'n Go' Barley Balls

Biodegradable gel spheres packed with barley straw extract. Simply drop one ball per week into pond (each ball treats 5000l).

Barley Balls **£14.99**



### Blagdon Barley Straw Bugs

Works like barley straw without the unsightly bales.

250ml RRP £17.99 **£15.99**  
500ml RRP £32.49 **£27.49**  
1ltr RRP £59.49 **£49.49**



3 for 2 Pack



### PondXpert Twin Pack

The traditional method against blanket weed and algae. Float the net of barley straw just below the surface. Each bale treats 2250 Ltrs.

Twin Pack **£9.99**

### Barley Straw Midi Bale

Larger bales for big ponds. Each log treats 13,500 Litres (3000 gallons) for 8 weeks

Midi bale RRP £29.99  
Our Price **£14.99**



### PondXpert Barley Flakes

Unlike traditional barley straw which sits on the pond surface these 'Flake' pouches are designed to sink to the pond bottom.

RRP £14.99  
Our Price **£7.49**



### Tetra AlgaFin

Effective and safe treatment for persistent blanketweed and other pond algae.



250ml (5,000) RRP £10.29 **£9.99**  
500ml (10,000) RRP £17.12 **£15.99**  
1ltr (20,000) RRP £28.61 **£24.99**

# Pond Treatments - BlanketWeed Cures



Before



After



## Buy 1 Get 1 Free with Blanketweed Beater Sixpack

Simply drop one water-soluble sachet into your pond or filter every week. Each sachet treats up to 4500 litres/ 1000 Gallons. **Pack of 6 £19.99**



### Cloverleaf Blanket Answer

Add to the pond by pouring mixed powder /pond water evenly over the surface. 800g will treat ponds up to 10,000 litres. Horticultural Magazine HDC awarded this product their antiblanketweed "Best in Test".

0.8kg Was £22.99 **Our Price £21.99**  
2.0kg Was £45.99 **Our Price £43.99**  
4.0kg Was £78.15 **Our Price £74.99**

Buy 1 Get 1 Free



### PondXpert Sludge Shifter

Soluble nuggets that contain a multitude of beneficial bacterial strains. Simply toss a nugget into your pond once a week to clear up sludge, odour and assist in re-balancing your ponds water quality. Six nugget pack - each nugget treats 4500 litres (1000 gallons).

RRP £39.99 **Our Price £19.99**

Buy 1 Get 1 Free



### PondXpert Green Water Beater

Powdered solution contained in soluble bags. Friendly bacterial strains that positively affect your pond's balance. Toss a sachet into your pond once per week and it will dissolve to counteract poor pond nitrate and phosphate levels. Great for getting rid of slimy algae, odour and green water.

RRP £39.99 **Our Price £19.99**

NEW



### Tetra PhosphateMinus 250ml

Reliably reduces high phosphate levels (PO4) in ponds, thereby preventing algae growth. One bottle treats 5000 litres of water.

RRP £11.34 **Our Price £9.99**



### EA Stop Blanketweed

Kills and prevents regrowth of blanketweed. Powerful biocide which effectively does the job. 1 kg treats 10,000l.

1kg RRP £21.95 **Our Price £16.99**  
2.5kg RRP £43.95 **Our Price £34.99**  
4kg RRP £64.95 **Our Price £49.99**



### Blanket Weed Brush

It's always best to hook out as much stringy blanketweed before you add any treatments. This brush with 1.8m telescopic pole is designed for the job.

RRP £29.99 **Our Price £14.99**

**Save £1.99** on buying pole and head separately - see pg 67



**New Ponds:** Any new pond build should be left unstocked until at least six weeks have elapsed in order to allow the pond's natural eco-balance to level. Beneficial 'friendly' bacteria will build up and breakdown any harmful toxins. A simple test kit will allow you to take water samples to measure pH (6-8 is ideal, 7 perfect), ammonia, and nitrate.

## Water Testing Equipment



### Tetra 6in1 Handy Test Pack

Test for Chlorine, pH, Carbonate, Hardness, Nitrite & Nitrate. Handy pack of 25 tests.

RRP £13.65 **Our Price Only £11.99**



### Blagdon Dip Test Kit

Quick & easy strip tests. Contains tests for ammonia, nitrite, nitrate, pH and water hardness. 60 tests.

RRP £16.69 **Our Price £13.49**



Buy 1 get 1 Free

### PondXpert Test 6in1

Test for Chlorine, pH, Carbonate, Hardness, Nitrite and Nitrate. Super value pack of 6 tests.

RRP £9.99 **Our Price Only £4.99**

**Water Conditioners:** Tap water is toxic to fish as it contains chlorine and other chemicals. This should be neutralised with a treatment. Alternatively collected rainwater can be used. Bacterial boosters add friendly bacteria to the pond quickly - speeding up maturation

500ml treats up to 4,546 litres.



### Blagdon Fresh Start

Removes chlorine.

**250ml** RRP £13.99 **£11.99**  
**500ml** RRP £21.99 **£18.49**  
**1litre** RRP £29.99 **£25.99**



### Blagdon Bio Start

Contains bio-cultures that balance pond. 4 sachets.

treats 9000lts **£15.99**



### Nishikoi Goodbye New Pond Problems

Contains bio-cultures. 2 soluble sachets

treats 9000lts **£7.99**

### PondXpert Tap Water Tonic 473ml

Treatment removes chlorine, chloramine and detoxifies any heavy metals that are present in tap water. Also neutralises any ammonia traces evident. Essential for new ponds or when making a water change.

Also contains a slime coat protectant to the water to help heal any wounds your fish have endured. This also protects your fish in times of stress: fish can find water changes and clean-outs stressful.

473ml bottle can be used to successfully treat 12,112 litres of pond water.

RRP £39.99 **Our price £19.99**



### Tetra Pond AquaSafe

Makes tap water safe by removing chlorine, chloramine and detoxifying any heavy metals that are present.

**250ml** RRP £10.29 **£9.99**  
**500ml** RRP £17.12 **£15.99**  
**1litre** RRP £28.61 **£24.99**



# Pond Treatments - Water Problem Solvers

## Slimy Algae/Greenwater



### Goodbye Greenwater

Simple water soluble sachets especially effective against slimy algae and greenwater.

**8 wk treatment** for 4500l **£14.99**



Buy 1 Get 1 Free



### PondXpert Green Water Beater

Friendly bacterial strains held within a dissolvable sachet. Simply toss one into your pond weekly. Great for getting rid of slimy algae, odour and green water.

RRP £39.99 **Our Price £19.99**



### Green Away

Non toxic treatment clumps algae together so they sink or are removed by filter. See UVCS.

**250ml** (11,365l) RRP £13.99 **£11.99**  
**500ml** (22,730l) RRP £21.99 **£18.99**  
**1 ltr** (45,460l) RRP £29.99 **£25.99**

## Dirty Water



### Sludge Buster

Contains millions of bacteria which actively consume organic sludge. Use after anti algae products.

**9000 Ltr pack** RRP £29.99 **£15.99**



### Tetra Crystal Water

Effectively eliminates dirt particles clarifying your water. Works fast. Not suitable for sturgeon-like fish.

**250ml** RRP £13.99 **£9.99**  
**500ml** RRP £17.12 **£15.99**  
**1ltr** RRP £28.61 **£24.99**



### Clear Pond

Clears dirty, cloudy water by clumping together fine suspended clouding particles, which then sink and clear pond water.

**250ml** (5,682l) RRP £13.99 **£11.99**  
**500ml** (11,364l) RRP £21.99 **£18.49**  
**1ltr** (22,730l) RRP £29.99 **£25.99**

### PondXpert Particle Blaster (236ml)

Clears dead or suspended particles. Ideal for clearing dead blanketweed following Eliminator treatment.

Treats 2500 gallons (11,170 litres).

**Our price £14.99**





# Pond Treatments - Fish Health



**Blagdon Liquid Treatments Range** 250ml treats 2273Lts (500 gal) 1litre treats 9092Lts (2000 gal).

 <p><b>Blagdon Pond Salt</b> Small treats 2250l, Large treats 9000l. 2.27kg <b>£11.99</b> 9.08kg <b>£39.99</b></p>	 <p><b>Blagdon Ammonia Remover</b> Removes toxic ammonia &amp; chloramine from ponds 500ml <b>£18.49</b></p>	 <p><b>Blagdon Stress Away</b> Keep disease away 250ml <b>£11.99</b> 1litre <b>£25.99</b></p>	 <p><b>Blagdon Duckweed Buster</b> Prevents the growth of duckweed. 250ml (2273l) <b>£15.99</b> 1ltr (9092l) <b>£49.99</b></p>	 <p><b>Blagdon Anti-Fungus</b> Treats fungus, finrot &amp; mouthrot 250ml <b>£11.99</b> 1litre <b>£25.99</b></p>
--	---	--	---	--

 <p><b>Blagdon Anti Ulcer</b> Treats ulcers, gill disease and dropsy. 250ml <b>£16.99</b> 1litre <b>£42.99</b></p>	 <p><b>Blagdon pH Adjuster Alkaline Ponds</b> Takes ph below 8.5 treats 5675lts <b>£11.49</b></p>	 <p><b>Blagdon pH Adjuster Acid Ponds</b> Takes ph above 6 treats 5675lts <b>£11.49</b></p>	 <p><b>Blagdon Anti Parasite</b> Treats white spot, flukes &amp; slime disease. 250ml <b>£11.99</b> 1litre <b>£25.99</b></p>	 <p><b>Blagdon All in 1 Fish Treatment</b> Help treat parasite, fungus and bacterial infections. Treats white spot &amp; fin rot. 250ml <b>£11.99</b> 1litre <b>£25.99</b></p>
--	--	--	---	--

# Pond Treatments - Fish Health & Water Quality



**PondXpert Concentrated Liquid Treatments Range**

Extra concentrated for best value: 250ml treats 5680Lts (1250 gal) 1litre treats 22750Lts (5000 gal).

 <p><b>Total Pond Health</b> Vitamin packed formulation promotes healthy water. 250ml <b>£8.99</b> 1litre <b>£19.99</b></p>	 <p><b>Anti-Parasite</b> Helps prevent parasite &amp; ulcer. 250ml <b>£8.99</b> 1litre <b>£19.99</b></p>	 <p><b>Anti Fungus &amp; Bacteria</b> Powerful disinfectant against fungal &amp; bacterial ailments. 250ml <b>£8.99</b> 1litre <b>£19.99</b></p>	 <p><b>Anti Blanket Weed</b> Hydro gel technology safely controls algae. 250ml <b>£8.99</b> 1litre <b>£19.99</b></p>	 <p><b>Anti Cloudy Water</b> Water clarifying agent - controls murky or cloudy water. 250ml <b>£8.99</b> 1litre <b>£19.99</b></p>
--	---	---	---	--

 <p><b>Anti Green Water</b> Clears green looking water caused by algal growth. 250ml <b>£8.99</b> 1litre <b>£19.99</b></p>	 <p><b>Anti Duckweed</b> Tackles unwanted duckweed by roots and leaves. 250ml <b>£8.99</b> 1litre <b>£19.99</b></p>	 <p><b>Anti Chlorine</b> Makes tap water safe. Neutralises chlorine. Added Vitamin B1. 250ml <b>£8.99</b> 1litre <b>£19.99</b></p>	 <p><b>Barley Straw Essence</b> Effectively clears blanketweed and green water. 250ml <b>£8.99</b> 1litre <b>£19.99</b> <small>Safe to use. Not affected by recent HSE recall</small></p>	 <p><b>Pond Salt</b> Improves fish health and improves natural eco-balance. 500g treats 2250 litres 1kg treats 4500 litres 500g <b>£8.99</b> 1kg <b>£14.99</b></p>
---	--	---	--	---

# Fish Food



### Fibbert Frog's Top Tip

Only feed once a day at season end/start (5-8°C). In summer (10°C) can feed 2-3 times. Remove any uneaten food after 5 minutes.

**In established pools**, where there is a good balance of plants, wildlife and fish there will be plenty of natural food for your fish to feed on.

However, pond food acts as a supplement to the fishes' diet and is enjoyable for the pondkeeper.

Often ponds will be more heavily stocked and there may not be enough plant life to attract insects.

Here feeding is vital to the health of the fish. High protein foods should be fed in the summer with only low protein (eg, wheatgerm) fed in the winter.

## Tetra Floating Sticks

A complete staple food for all fish. The UK's bestselling pond food.

780g	£16.99
1.2kg (10ltr bucket)	£21.99
1.68kg	£29.99
3.0kg	£39.99
4.2kg	£49.99



## Tetra Koi Sticks

A complete food for all koi. High digestibility. 31% protein.

650g	£15.99
1.1kg	£23.99
1.5kg (10ltr bucket)	£29.99
2.35kg	£39.99
7.5kg	£99.99



## Tetra Variety Sticks

A mix of pond, koi and wheatgerm sticks for all fish.

600g	£14.99
1.02kg	£21.99
1.65kg (bucket)	£29.99
2.12kg	£39.99
4.10kg	£54.99



## Nishikoi Staple Food Pellets

A floating food that is a complete diet for all pond fish. 28% protein.

750g	£14.99
1.250kg	£22.99
2.5kg	£39.99
5.0kg	£69.99
10.0kg	£99.99



## Nishikoi Growth Food

A floating food promotes health & steady growth. 37% protein.

750g	£19.99
1.250kg	£29.99
2.5kg	£49.99
5.0kg	£89.99
10.0kg	£129.99



# Pond Feeding Equipment

## SUMMER SALE

The future of feeding has arrived...

Save £30



## PondXpert FoodFinger Pond Fish Feeder

Feeds your fish when you are not available. New Auto-Feeder with solar power. Very easy to use with full control via LCD control panel. Clever anti-clog design means regular, reliable feeding.

RRP £239.99 Was £119.99 **Sale Price £89.99**

## Super Features

- Rechargeable batteries powered by solar
- 6 Litre capacity accepting pellet & stick food
- Control size of feed (0 to 20 seconds)
- Control number of daily feeds (1-6)
- Control 'scatter power' (60-100%) distance

Accepts pellet & stick style food 3-10mm.

Includes 4 stake feet for optional additional stability.

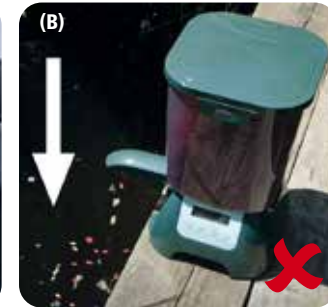

(A) PondXpert FoodFinger offers powered propulsion. Food can be propelled a controllable distance (3ft to 10ft) at wider arc of 160 degrees.

- Allows multiple siting opportunities
- Fair distribution of food enabling all fish to feed

(B) Traditional 'auto-feeders' can be troublesome to position pond-side. The food drops down vertically from a chute into the water. Greedy fish can monopolise meals.

## FoodFinger Mains Adaptor

FoodFinger powers its rechargeable batteries (supplied) via an integrated solar power. One charge lasts up to 3 months but an optional Mains Charger is available.

RRP £19.99 **Our Price £9.99**



## Introducing

**pondXpert**  
nutrition+ Pond Food

Nine super varieties to cover all pond fish requirements.

Seven mainline foods available in three handy sizes:

**1KG Bags**

**4Kg Bags**

**10kg Bags**

(Save 50% buying a 10kg bag vs 1kg).



## Bestselling Food Range Improved

Food Variety	Description	Protein
Mixed Blend	Triple blend - 2 colour sticks & pellet mix	28%
Growth Pellets	4mm diameter round pellets	32%
Koi Sticks	Classic stick shaped food for koi and all fish	29%
Pond Sticks	Classic stick shaped food for all fish	27%
Oranges & Cream	Classic mixed colour sticks food for all fish	28%
Staple Pellets	5mm diameter round pellets	27%
Wheatgerm	Easily digestible pellets, perfect for winter	22%
Pond Flake	Crumbles in hand	16% 800g bags only
Bottom Sinking	4.5mm pellets for sturgeon & sterlets	34% 2.5kg bags only

*All foods include vitamins, minerals & spirulina for fish health.*

### Sinking Pellets

High protein food designed specifically for bottom-feeding fish such as sturgeon, sterlets.

Remember to observe fish activity throughout year as some bottom feeders will continue to feed in winter.

Approx. 3.6 Litres

2.5 kg RRP £39.99

**Our Price £19.99**



### Pond Flake

Perfect for all fish but particularly small or medium surface feeding fish in your pond.

Flakes break down into smaller pieces and are easily digestible.

Approx. 4 Litres

800g RRP £39.99

**Our Price £19.99**



### Orange & Cream Sticks

Mixed colour sticks. A great 'allround' food and suitable for all surface feeding fish.



1kg

£9.99

4kg

£29.99

10kg

£49.99



All Foods available in 3 handy sizes. Save 50% per KG with our bulk bags.

**FREE**  
"Taster" Sample Packs Available, phone for details

### Mixed Blend

Popular blend of sticks and pellets. Various piece sizes make this a great choice for mixed fisheries.



1kg

£9.99

4kg

£29.99

10kg

£49.99

### Koi Sticks

Higher protein food designed specifically for koi and other large fish.



1kg

£9.99

4kg

£29.99

10kg

£49.99

### Pond Sticks

Popular food for goldfish, koi and all other surface feeding fish.



1kg

£9.99

4kg

£29.99

10kg

£49.99

### Wheatgerm Pellets

Low protein food, easily digestible (4mm), perfect for feeding during winter and early spring.



1kg

£9.99

4kg

£29.99

10kg

£49.99

### Staple Pellets

As the name suggests a food perfect for regular feeding throughout the year. Suitable for all fish.



1kg

£9.99

4kg

£29.99

10kg

£49.99

### Growth Pellets

High protein food designed specifically for growing-on of koi during the warmer months.



1kg

£9.99

4kg

£29.99

10kg

£49.99

# Pond Feeding Equipment

## Hozelock Automatic Fish Feeder



Indispensable for holiday feeding, the Automatic Fish Feeder can be mounted on a pond wall or on the supplied stand. Operate via a single control incorporating a battery-operated clock and a frequency dial which gives a choice of up to six feeds per day. The food chamber holds up to 800ml (approx. 100g) of fish food.

RRP £184.99 **Our Price £99.99**



## Fishmate Fish Feeder

Automatic fish feeder for up to 21 days. Reliable and accurate timer AA battery included.

RRP £59.90 **Our Price £49.99**

## Fish Mate P7000 Pond Fish Feeder

**FISH MATE**

Suited to larger ponds for use with pellet or 'stick' food. Variable feed sizes are dispensed at programmed times or on demand at the touch of a button.

- 7 Litres/ 6.5lbs / 30 cup capacity dry food hopper.
- Easy to use LCD control with approximately 6 to 9 months battery life in continuous use.
- Unique feed mechanism ensures accurate and consistent feed sizes from teaspoons upwards.
- Weather-resistant
- Can be fastened to a secure base for increased stability.
- Suitable for most popular food sticks and pellets

Fishmate P7000 feeder RRP £115.23 **Our Price £84.99**



## PondXpert Thermometer

Knowing the correct water temperature of your pond water is vital when to feed and add treatments. This floating thermometer gives you the information you need.

RRP £19.99 Was £9.99 **Sale Price £7.99**



## PondXpert Feeding Ring

Floats on surface and allows easy removal of uneaten food & prevents food drifting around surface.

RRP £4.99 **Our Price £2.49**



## Supa Vacation Block

Concentrated block of fish food that will supplement the diet of your fish for up to two weeks.

- 50 gramme block
- Protein 40%, Fat 8%, Fibre 2%, Moisture 8%

RRP £2.99 **Our Price £2.49**



## Tetra Holiday Food

One block feeds 10-15 medium sized goldfish, or 2-3 medium sized koi, for 14 days. If your pond contains more fish, increase the number of blocks accordingly.

RRP £8.99 **Our Price £6.99**



# Pond Side Creatures

## Floating Ducklings (triple)

Set of 3 cute ducklings to complete the duck family.

**1 Ducklings** RRP 19.99 **£9.99**

Dimensions: LWH cm 11 x 6 x 6



**2 Owl** £12.99

Can be filled with sand for extra ballast or hung from tree (pierce hanging slot). Dimensions: LWH cm 16 x 16 x 42 (6' x 6' x 1'5")



**3 Floating Croc** £39.99



## Ducks

**4 Mallard Male** £9.99

**5 Mallard Female** £9.99

Dimensions: LWH cm 13 x 35 x 13 (5" x 1'2" x 5")



**6 Wind-Action Owl** £24.99

Ornamental bird with spinning head that works as a pest deterrent.



## Swans

**7 Swan Small** £19.99

**8 Swan Large** £39.99

**Swan Pair** £49.99 **Save £9.99**

'Pair' = Large & Small Swan

Dimensions: LWH cm

**Small** 33 x 18 x 24 (1'1" x 7" x 9")

Dimensions LWH cm

**Large** 81 x 33 x 41 (2'8" x 1'1" x 11'4")



"Adds a touch of majesty to our pond"  
.....  
"Really nicely made and float well"

# Pond Lighting



**The right lighting** enables you to create limitless effects in your garden.

Lighting displays are magnified by the reflective nature of water while fountains and waterfalls look even more dramatic at night.



## Pondxpert Pondlight LED 3

As above but just 5w running costs

RRP £79.99

**Our Price £39.99**



**- Special Offer -**

Twin Pack £79.98

**Our Price £59.99**



### Fibbert Frog's Top Tip

Halogen bulbs offer a wider beam of illumination. LED bulbs last for many years providing an intense narrow light beam at lower wattage.

Use in or out of the water



RRP £79.99

**Our Price £39.99**

## Pondxpert Pondlight Halogen 3

This triple 10w halogen spotlight set can be used in or out of the water. The three lights are connected to a low voltage 12v/30w transformer for safety.

- Adjustable light angle.
- 5m electrical cable between transformer and first light - 1m between each other light
- Supplied with 3 packs of 4 coloured lenses: red, green, yellow and blue.
- 1 year guarantee



# Pond Lighting

## PondXpert Brightpond LED

New energy efficient outdoor and submersible LED Garden/Pond Lights perfect for illuminating your garden or pond. Supplied with a variety of coloured lenses, easily interchangeable by simply twisting-off the lamp cover.

Each lamp has a total of 12 LED Bulbs for a bright and energy efficient illumination. Each lamp set includes a weighted tripod and suction pads for easy placement.

### Lense Colours Included:

White, Green, Red, Blue, Orange.

LED Lamp Power: 1w, 12v Safety Transformer, Transformer with 2 Meter Cable, 10m Cable from Transformer to 1st Light, then 1.2m between each Subsequent Light.

**Quad** supplied as 2xDuo set (2 transformers)

**Quintet** supplied as 1xDuo and 1xTrio set (2 transformers)



**BrightPond LED Duo**

RRP £99.99 **£49.99**

**BrightPond LED Trio**

RRP £119.99 **£59.99**

**BrightPond LED Quad**

RRP £149.99 **£74.99**

**BrightPond LED Quintet**

RRP £159.99 **£79.99**



### Halogen v LED

Traditional halogen offers a warmer light with yellow tinge.

LED lights are 'sharper' and 'whiter' with a narrower beam

LED bulbs last longer and take less power to illuminate



## PondXpert Brightpond Halogen Pond Lights

**Single 20w**

RRP £69.99 **Our Price £34.99**

**Duo Set (2 x 20w lamps)**

RRP £99.99 **Our Price £49.99**

**Trio Set (3 x 20w lamps)**

RRP £119.99 **Our Price £59.99**

**Quad Set (4 x 20w lamps)**

RRP £149.99 **Our Price £74.99**

**Quintet Set (5x 20w lamps)**

RRP £159.99 **Our Price £79.99**

### Product Description

Attractive pond lights suitable for use above or below water. These lights are easy to position thanks to weighted tripod stands and ground stakes (included)

Each powers a 20w halogen bulb and comes complete with transformer and four coloured discs.

2m Cable from plug to weatherproof transformer, then 5m to first Light, then 2m to Subsequent Lights.

# Pond Lighting

## SolarSublight SUPER - Premium Solar Submersible Lighting

Powerful solar lighting with enhanced solar power and higher capacity lithium batteries. Includes brightness level option (High/Low).

All models supplied with extra-power 3.5W Panel and high capacity lithium battery

### SolarSublight SUPER Quad Set

A set of FOUR solar underwater lights.

Two lengths of main cable allow for extended positioning possibilities for the consumer.

### Specifications

Solar Panel: 3.5 Watts

Lithium Battery: 3.7v/3600mAh

Lighting Power: 1.2W per light (144 lumens)

Set illumination: 4.8W / 576 lumens

Cable Length: 3 mtrs x 2 (1.15m between lights)

### Running Time

Low Light: 24 hrs High Light 12 hrs Charge time: 8 hrs



'Warm White' colour

Dusk 'til Dawn  
Auto illumination

# Pond Lighting

## PondXpert Solar Submersible Lighting

Waterproof solar powered LED spotlights that can be used in or out of the water. Lights will illuminate automatically at night for 8 hours if battery fully charged.

Lamp power 0.4W



'Bright White' colour

Model	Lamp Power	Battery	Power Cable	Running Time Hrs		RRP	Was	SALE PRICE
				Low Light	High Light			
SolarSublight SUPER Triple White	1W	3.7v/2200mAh	3m+1.15m x 2	14	7	£99.99	£49.99	£39.99
SolarSublight SUPER Triple RGB	1W	3.7v/2200mAh	3m+1.15m x 2	n/a	10	£109.99	£54.99	£44.99
SolarSublight SUPER Quad White	1.2W	3.7v/3600mAh	3m x 2+1.15m x 3	24	12	£119.99	£59.99	£49.99

## Our most powerful solar lights - Twice the Brightness!



### SolarSublight SUPER Triple Set RGB

Auto-Cycle Colours auto-rotate between approx 7 colours  
Fixed Colour Lights can be fixed on Red, Green or Blue



### SolarSublight SUPER Triple Set

Choose between Low/High Brightness Illumination



Model	Power	Power Cable	RRP	Was	SALE PRICE
Solar SubLight Single Light White	0.3w	3.2m	£49.99	£24.99	£19.99
Solar SubLight Duo Lights White	0.6w	3.2m	£59.99	£29.99	£24.99
Solar SubLight Triple Light White	2.5w	3.2m+1.15m	£79.99	£39.99	£29.99
Solar SubLight Triple Light Colour	2.5w	3.2m+1.15m+1.15m	£89.99	£44.99	£34.99

### 2 in 1 Installation



### Lighting Modes (RGB Only)

Fixed colour - green, blue or red.

Multi colour - cycles through RGB.

# Pond Plants

Water gardens give the keen horticulturist an opportunity to grow a number of aquatic-friendly species.

Introducing plants to your pond is beneficial for optimising 'pond balance'.

## Live Pond Plants

We are delighted to be able to offer you a top selection of plants from the UK's best aquatic nursery. Our customers love our Variety Packs of Six 9cm plants - Your Pack of 6 will be made from a selection of 13 plants. These will be chosen by the nursery pickers based on availability and quality of the plants at time of despatch (ie, what is in-season).

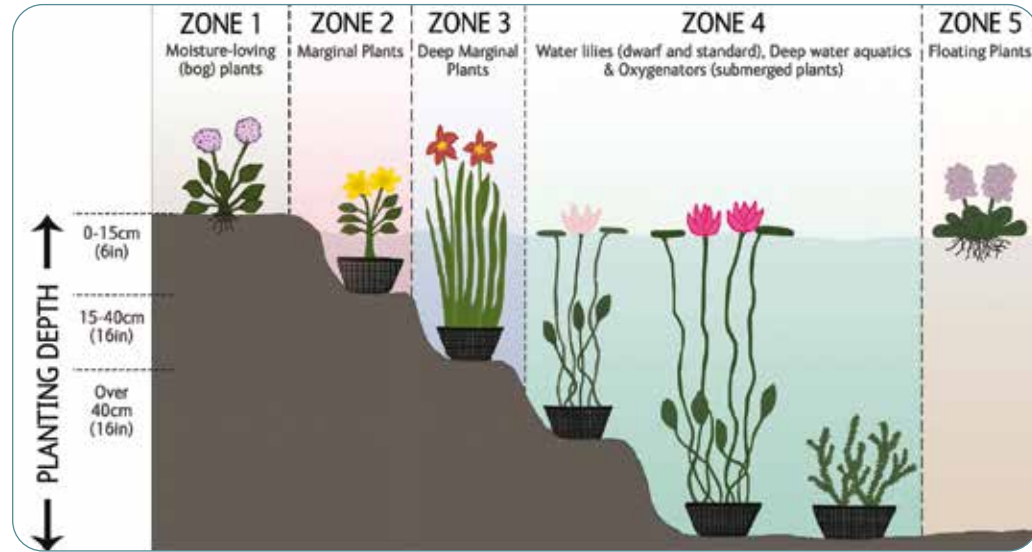

★★★★★  
100%  
5  
Customer Reviews

### Ornamental Marginal Variety Pack

Marginal Plants grow well in wet or water logged soil near the water garden's edge or in shallow water.

**Our Price £49.99**



★★★★★  
100%  
9  
Customer Reviews

### Oxygenator Plants Variety Pack

Submerged beneath the water's surface, these plants release oxygen into the water (essential for a healthy pond).

**Our Price £49.99**



★★★★★  
100%  
4  
Customer Reviews

### Wildlife Marginal Variety Pack

Great Pollinators as well as being British Natives. Will attract a wide variety of pollinating insects and other wildlife.

**Our Price £49.99**

### Water Lilies (1 ltr pot)

Spectacular flowering plant.

- Red Lily £29.99
- White Lily £29.99
- Yellow Lily £29.99



# Pond Plants

As well as looking beautiful aquatic plants play an important part in keeping your pond balanced. Plants absorb nutrients, reduce light levels in the water and produce oxygen. Plants also provide shelter for fish and natural material on which they might spawn.

## Planting Baskets

Aquatic planting baskets have been designed with mesh to help retain the soil. A fabric liner can be used to reduce any soil leaching.

★★★★★  
100%  
37  
Customer Reviews

3 for 2



### How to choose a planting basket size.

**Submersed Plants:** 10cm wide or kidney shape and larger.

**Bog Plants:** 18-23cm wide for small bog plants, 28-36cm wide for large bog plants like Iris. Kidney shape baskets are also great for arrangements of 3-4 young bog plants.

**Water Lilies:** 20-25cm wide work for Dwarf lilies, but for regular lilies we recommend the XL 40cm size.



### Fibbert Frog's Top Tip

Did you know a 10 litre bag of soil will fill 1 x kidney basket? In order to help you decide how much soil you need we have added a 'capacity' column next to our planting baskets. Hope this helps!

## Planting Bag

Easy to use, more flexible than baskets, fit in small areas.

★★★★★  
100%  
5  
Customer Reviews

3 for 2

### PLANTING BAGS

Type (L x W x D) cm	Triple	Single
Small round 15 dia x 15	£2.99	£1.49
Med. round 25 dia x 20	£3.99	£1.99
Small square 18 x 18 x 18	£2.99	£1.49
Med. square 25 x 25 x 20	£3.99	£1.99
Large square 30 x 30 x 25	£4.99	£2.49



## "Fat" Kidney Baskets

37 x 24cm **£1.99** **£3.99** for 3

### PLANTING BASKETS

Type (W x D) cm	Volume	Triple Pk	Single
Small round 14 dia x 10	1 ltr	£1.99	£0.99
Med. round 21 dia x 13	3 ltr	£3.49	£1.99
Mini square 11 x 10	1 ltr	£1.99	£0.99
Small square 20 x 10	2.5 ltr	£2.99	£1.49
Med. square 24 x 15	5 ltr	£3.99	£1.99
Large square 29 x 20	10 ltr	£4.99	£2.49
"Thin" Kidney 45 x 18	8 ltr	£3.99	£1.99
Xlarge square 31 x 25	12 ltr	£6.99	£3.49
Lily basket 40 dia x 29	30 ltr	£15.99	£7.99

## Plant Sock

Plant/soil holder which can be formed into a flexible 'sausage' shape. Buttons then stop soil falling out. Great for nooks & crannies.

- Small Sock 10dia x 80cm **£7.99**
- Large Sock 15dia x 80cm **£8.99**

★★★★★  
100%  
2  
Customer Reviews



## PondXpert Hessian Squares

Traditional material used for lining baskets. 45cm x 45cm Pack of 3.

RRP £7.99 **Our Price £3.99**

★★★★★  
100%  
8  
Customer Reviews



## Fine Lining Squares 5 pack

Vey fine mesh means no soil can escape with this black fibre. 50x50cm **Our Price £2.99**  
100x100cm for lily basket. Single RRP £3.99 **Our Price £1.99**

★★★★★  
90%  
10  
Customer Reviews

# Pond Plants

## Aquatic Soil

Premium, fertiliser free. Suitable for all plants. 20kg - let us take the strain!

10 Litres **£7.99**  
20 Litres **£12.99**



## Pond Gravel

Cover material for soil and plant baskets. Gravel size 4/6mm

8 Litres **£7.99** **New**  
2 Litres **£4.99** **Mini Pack**



**- Special Offer -**  
10l soil & 8l gravel combo deal **£14.99**

## PondXpert Floating Planters

A beautiful way to display pond plants

- Plants kept watered automatically
- Planters can be joined together

### Round Planter Small

(25cm) RRP £19.99 **£9.99**

### Round Planter Medium

(35cm) RRP £29.99 **£14.99**

### Square Planter Small

(25cm) RRP £21.99 **£10.99**

### Square Planter Medium

(35cm) RRP £31.99 **£15.99**



**Special 'Combo' Offer** Round Planter Small & Medium Planter Set **£18.99**  
- Save **£5.99** Square Planter Small & Medium Planter Set **£20.99**



## Laguna Round Floating Planters

This great idea allows marsh plants to be positioned anywhere. Floating and linkable plant basket.

**Small** 25cm dia RRP £12.99 **£10.99**

**Large** 35cm dia RRP £17.49 **£14.99**

**25/35cm Set** RRP £25.29 **£22.99**

**SAVE £2.99**



## Laguna Square Floating Planters

New kit containing two square floating planters sized 25cm & 35cm.

Square Planter Kit  
**Our Price £24.99**



## Velda Floating Plant Oasis

Floating planter island suitable for 6 x 9cm plug plants. Dimensions 40 x 30 x 5 cm (LWH).

**Floating Plant Oasis**  
**Our Price £9.99**



**Free Pots worth £2.94**

# Pond Plants 'Dry' Plant Selection from Holland

These 'dry pack' plants represent a great saving compared with "wet plants". Being dry packed means plants can be stored until you are ready to plant, or they can be given as great gifts.

*Grow Pond Plants Anywhere!*

## Moerings Plant in a Basket

Dried plants packed in a planting basket. Supplied with plant, soil and gravel (as shown in bottom right hand corner of this page).

### Contents:

1 x 19x19x10cm basket 2 plants per basket 1 lily per basket.



**Iris £8.99**



**Typha £8.99**



**Acorus £8.99**



**Pontederia £8.99**



**Yellow £9.99**



**Red £9.99**



**White £9.99**



**Pink £9.99**



## Moerings Floating Ring Kit

Square Floating Planter (20 x 20cm) and 3 plants. Plants randomly selected depending on season.

**£12.99**



**All Plant kits contain everything you need**

Packs include plant(s), soil, planter and gravel.



## Over Liner Mat Planting Mat

Planting material with pockets. Hide exposed liner with plants for a more natural look.

1.10 x 1.05m

RRP £22.00

**Our Price £14.99**



**10**

## PondXpert PondBloom Fertiliser

Designed to keep aquatic plants vigorous and beautiful. Simply use 1-2 tablets monthly per 3-4 litres of soil. 5 tablet pack.

RRP £9.99

**Our Price £4.99**





# Pond Plants

Artificial plants offer an attractive option to growing the real thing.

They add a touch of instant colour, require zero maintenance and can't be eaten by any fish you may have in the pond.



Note: colours vary

## Floating Lily Set

**Triple Pack**  
Dimensions:

20cm, 18cm, 10cm

**Artificial Lilies**

RRP £29.99

**Our Price £14.99**



## Artificial - Underwater Plants

**Artificial Pond Plants - Underwater Oxygenators** 1m height (50cm height Ideal for preform ponds & shallow ponds).



- Artificial Oxygenator (A) 50cm** RRP £19.99 **£9.99**
- Artificial Oxygenator (B) 50cm** RRP £19.99 **£9.99**
- Artificial Oxygenator (C) 50cm** RRP £19.99 **£9.99**
- Artificial Oxygenator (D) 50cm** RRP £19.99 **£9.99**
- Artificial Oxygenator (E) 50cm** RRP £19.99 **£9.99**

- Artificial Oxygenator (A) 1m** RRP £39.99 **£19.99**
- Artificial Oxygenator (B) 1m** RRP £39.99 **£19.99**
- Artificial Oxygenator (C) 1m** RRP £39.99 **£19.99**
- Artificial Oxygenator (D) 1m** RRP £39.99 **£19.99**
- Artificial Oxygenator (E) 1m** RRP £39.99 **£19.99**

- ✓ **Bestselling decorative item**
- ✓ **Fish use plants for spawning. Much more attractive than 'brushes'**

- ✓ **Add instant colour to a new pond**
- ✓ **Creates a spectacular dancing underwater feature when placed above air pumps**

## PondXpert PondBloom Fertiliser

Designed to keep aquatic plants vigorous and beautiful. Simply use 1-2 tablets monthly per 3-4 litres of soil. 5 tablet pack.

RRP £9.99

**Our Price £4.99**



## Velda Growth Balls

Convenient pack of 50 fertiliser tablets. Perfect for enhancing growth of all pond plants including lilies and marginals.

RRP £5.29

**Our Price £4.99**



# Pond Hose Fittings

## Universal Flow Regulator

Adjust pump flow  
20 / 25 / 32 / 40mm

**Blagdon**

RRP £30.49

**Our Price £27.99**

**Hozelock**

RRP £26.79

**Our Price £24.99**



## Hozelock 25mm Flow Regulator

Flow restrictor  
25mm (1")

RRP £9.69

**Our Price £8.99**



## Laguna Universal Joiner

Joins all hose sizes

**5-20mm** RRP £4.69

**Our Price £3.99**

**20-40mm** RRP £7.99

**Our Price £6.99**



## PondXpert Universal Joiner

Joins hose  
20/25/32/40mm

RRP £25.99

**Our Price £12.99**



## Small 'T' Piece

Joins hose  
12/20/25mm

RRP £9.79

**Our Price £8.99**



## Large 'T' Piece

Joins hose  
40/32/25/20mm

RRP £19.69

**Our Price £16.69**



## PondXpert Universal Flow Regulator

38/32/25mm (down to 20mm one end).

RRP £39.99

**Our Price £19.99**



## Threaded Hosetails

3/4" (20mm) Hose 12-25mm **£5.29**

1 1/4" (32mm) Hose 20-40mm **£5.79**

1 1/2" (40mm) Hose 20-40mm **£6.49**



## Rigid Pipe

**2" width x 150cm** **£9.99** (G2Clean/Clear Pond)

**70mm width x 48cm** **£9.99** (Biotec, Filtobox 12/25)

**70mm width x 100cm** **£14.99**

**70mm elbow 45 deg** **£7.99**

**70mm elbow 90 deg** **£7.99**

**3" x 3m pressure pipe** **£39.99**

**4" x 3m pressure pipe** **£49.99**



## Evolution Aqua Eazy Connectors

Flexible PVC fittings make connections from outlets to pipework easy. No messing with glue or solvents.

**Straight 2" connector** **£7.49**  
(63-50mm)

**Straight 1.5" connector** **£5.49**  
(50-38mm)

**2" to 1 1/2" Adaptor** **£7.99**

**3" to 2" Adaptor** **£10.99**

**4" to 1 1/2" Adaptor** **£16.99**

**4" to 2" Adaptor** **£16.99**

**4" to 3" Adaptor** **£16.99**

**2" Elbow (63-50mm)** **£8.99**

**1.5" Elbow (50-38mm)** **£6.99**

**1.5" End cap (50-38mm)** **£4.99**

**2" End cap (63-50mm)** **£5.49**



# Pond Hose Fittings

## PondXpert 'Y' Pieces

Split your water flow and control flow rate with taps.

Small (20/25mm) RRP £39.99

**Our Price £19.99**

Large (25/32/40mm) RRP £49.99

**Our Price £24.99**



Small 'Y' piece



Large 'Y' piece



# Pond Spares & Consumables

Here at pondkeeper we are keen to ensure that we provide everything you need to make your hobby a pleasure. Over the years we have developed a significant inventory of spare parts and consumable items (eg, replacement foams for filters and pump impellers). For a comprehensive list please visit the 'pond spares' section of our website or call us with any query you have.

## Filter Foam Media



**Filtobox 6000** £14.99  
**Filtobox 12000** £19.99

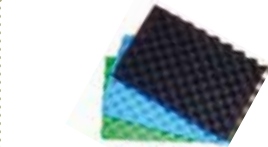

**Triple Layer Foams**  
17 x 11" (43 x 28cm) £9.99  
25 x 18" (64 x 46cm) £19.99  
43 x 21" (110 x 53cm) £39.99  
Trim to size - suits most box filters



**Fine Foam Media**  
17 x 11" (43 x 28cm) £3.49  
25 x 18" (64 x 46cm) £7.99  
43 x 21" (110 x 53cm) £14.99  
Trim to size - suits most box filters



**EasyFilter 4500 (2 foams)** £14.99  
**EasyFilter 9/12000 (3 foams)** £16.99  
**EasyFilter 20/30000 (2 foams)** £19.99



**Bioforce Rev Foams Pack** £34.99  
1 Pack for 6000 & 9000  
2 Packs for 14000



**EasyClear Single** £14.99  
**EasyClear 3000** (1) £14.99  
**EasyClear 6000** (2) £19.99  
**EasyClear 9000** (3) £24.99

# Decorative Solar Lighting Sale - All lines reduced by 50%

## PondXpert Solar Orbs

Was £29.99 **NOW £14.99**

## PondXpert Solar Rope

Was £19.99 **NOW £9.99**

## PondXpert Solar Lilies

Was £29.99 **NOW £14.99**



Pack of Three

Many more SALE items online

# Pond Hose & Clips

As your pond water makes its journey from your pump to its destination - via a UVC, filter or waterfall - it needs to be constrained by a network of hose. This hose should be fixed securely to the equipment using clips - this helps prevent any chance of the hose becoming loose or leaks affecting performance. As with most things items fail due to the weakest link, that is why we only use premium hose and accessories.



## PVC Pond Hose

Features:

- Smooth bore-minimal flow restriction
- Will not kink or split
- Convenient 5m lengths will suit most ponds



## Clips

Features:

- Zinc plated, will not corrode
- Easy to tighten



PRODUCT DESCRIPTION	Size 12mm	Size 20mm	Size 25mm	Size 32mm	Size 38mm	Size 40mm	Size 50mm
<b>5m Pre-cut Hose</b>	£12.99	£14.99	£18.99	£24.99	£29.99	£29.99	£47.99
<b>Bulk Length Hose</b>	30m	25m	30m	30m	30m	25m	20m
<b>Bulk Hose length Prices</b>	£59.99	£69.99	£79.99	£109.99	£134.99	£134.99	£229.99
<b>Zinc Hoseclips (pair)</b>	£3.99	£4.49	£4.99	£5.69	£6.99	£6.99	£5.29
<b>Union Hose Connector</b>	£2.69	£2.89	£3.19	£5.89	n/a	£7.29	n/a

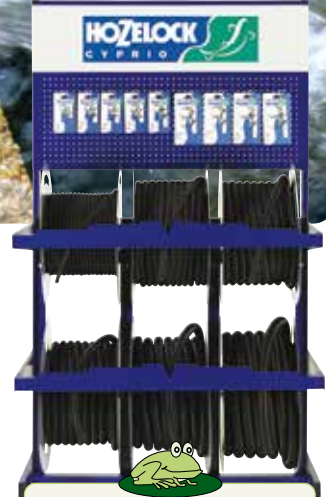

## Filbert Frog's Top Tip

Use the largest size of hose available for the equipment involved - this results in less frictional loss resulting in optimal performance.

# Order Information

## Delivery

Delivery is direct to your door from our warehouse and we aim to despatch all orders placed before 1pm on the evening of the same day. Your order will be despatched on a 24hr service and be with you the next day (anytime 8am-6pm). \*A standard charge of £4.99 is made to contribute towards handling and despatch. This charge is for mainland UK only - the following areas please ring for quote first (Isle of Man, Wight & Scilly, Northern Ireland, Channel Isles plus Scottish Highland & Island postcodes (BT, AB31-38, AB40-56, HS, IV, KA27-28, KW, PA20-88, PH4-44, PH49-50, ZE).

## Returns

If any item does not meet your expectations you may return it (unused) within 30 days of purchase. We will cover the cost of return for damaged or faulty goods. Please state whether you would like a refund or replacement when returning goods. Your statutory rights are not affected.

## Warranties

Most of our products come with free extended manufacturer warranties. If you incur any problems during this warranty period please let us know and if the item can not be fixed we will offer a replacement no problem. Proof of purchase required

## pondkeeper



## Mailing List

- Please remove me from your mailing list
  - We may make our customer list available to carefully selected companies.
- Please tick if you do not want to receive such mailings

Products in this catalogue may differ slightly from the published photograph. All products and prices are correct at time of printing (E&OE), subject to availability and may be subject to change (customers will be notified of any changes before ordering). All sizes and specifications quoted are approximate only. Whilst every attempt is made to deliver your order promptly and in perfect condition Pondkeeper denies any liability for consequential loss or expense caused by faulty items or delay in despatch or delivery. We strongly recommend that no arrangements for installation involving third party contractors are made until you are in receipt of your goods and have checked they are satisfactory. Copyright Armstrong Direct Ltd trading as pondkeeper reg'd in England 5601027.

## Solar Submersible Lights

**SUMMER SALE**



**NEW** Super Solar SubLights  
Quad Was £59.99  
**SALE PRICE**  
**£49.99**



See pg 106

pondXpert



Solar SubLights  
Triple Was £39.99  
**SALE PRICE**  
**£29.99**



See pg 107

## Pond Pump Sale

**SUMMER SALE**



### PondHero Super Jet Fountain Pump

Quality fountain pumps with two fountain displays (tiered & bell)

- 2300 LPH £59.99 **£39.99**
- 3000 LPH £69.99 **£49.99**
- 4700 LPH £79.99 **£59.99**
- 6200 LPH £89.99 **£69.99**



### PondHero PondForce Filter Pump

Super value filter pumps. Perfect for waterfalls & filters.

- 2300 LPH £54.99 **£34.99**
- 3000 LPH £64.99 **£44.99**
- 4700 LPH £74.99 **£54.99**
- 6200 LPH £84.99 **£64.99**



Low running costs  
20/25/32mm outlet



## NEW Exclusive - 100% Solar



### PondXpert TripleAction SOLAR 800

RRP £299.99 **OUR PRICE £149.99**

Set includes 450 LPH Pump for ponds up to 800 Litres (175 gallons) in size

**UVC PUMP FILTER**

### PondXpert TripleAction SOLAR 1600

RRP £399.99 **OUR PRICE £199.99**

Set includes 850 LPH Pump for ponds up to 1600 Litres (350 gallons) in size

pondXpert See pg 43

