



affinity<sup>®</sup>  
living feature pools

# view half-moon

mocha weave & black aluminium  
instructions



HOW TO  
BUILD YOUR  
AFFINITY VIEW  
SEE WEBSITE

[www.affinitypools.co.uk](http://www.affinitypools.co.uk)

[www.pondaquariumproblemsolver.co.uk/blagdon](http://www.pondaquariumproblemsolver.co.uk/blagdon)

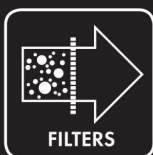



# View Half-Moon Assembly Instructions

Getting to know your Affinity living feature pool

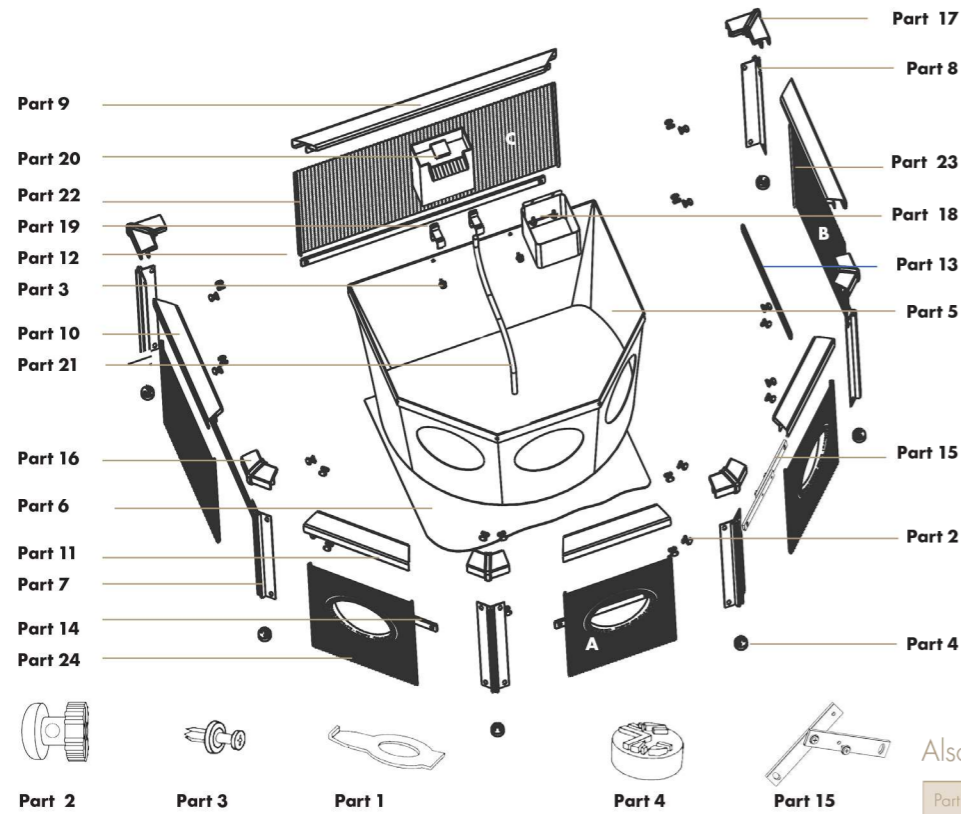

## Part List

Part Description	Quantity	Part No.
Tool	1	1
Plastic key	24	2
Plant basket Fixing Pin	6	3
Leg Feet	6	4
Half Moon Liner	1	5
Underlay	1	6
135 Degree Leg	4	7
90 Degree Leg	2	8
Back Top Rail (C)	1	9
Side Top rail (B)	2	10
Front Top Rail (A)	3	11
Back Leg Cross Brace (C)	1	12
Side Leg Cross Brace (B)	2	13
Front Leg Cross Brace (A)	2	14
Tension Bar	1	15
135 Degree Trident Connector	4	16
90 Degree Trident Connector	2	17
Plant Basket	1	18
Waterfall Clips	2	19
Waterfall	1	20
Waterfall hose	1	21
Mocha Weave back Panel (C)	1	22
Mocha Weave side Panel (B)	2	23
Mocha Weave window Panel (A)	3	24

## Technical specifications

35 gallons 29.7" w x 24.8" d x 23.6" inc waterfall  
133 lt 75.5cm w x 63cm d x 60cm inc waterfall

## Also Available

Part Description	Product Code
Blagdon Affinity Ice Vent Heater	1051545
Blagdon Affinity Plant Basket	1052245
Blagdon Inpond 2000 Maintenance Kit	1054690
Blagdon Affinity View Half-moon Replacement Liner	1055710
Blagdon Affinity View Half-moon Waterfall	1055727
Blagdon Affinity Green Water Clarifier	1051309

## Step by Step Guide

### Step 1

Please remove all of the relevant parts from the packaging and double check that all of the items are enclosed, use the complete parts list and the exploded diagram to check this.

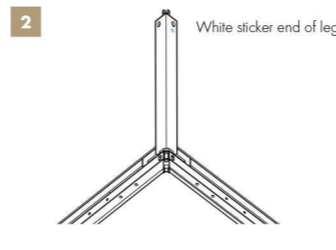
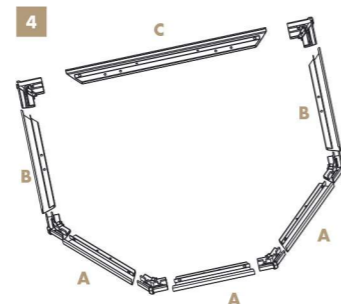
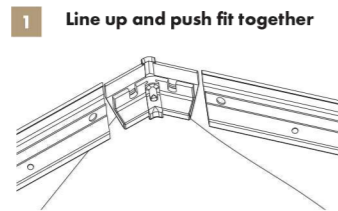

### Step 2

Identify a suitable area where your Affinity Pool can be placed, ensure that the area is level with a firm base and is free from stones or any other debris that could damage your liner bag.

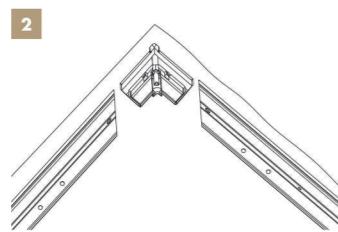

### Step 3

Using your supplied underlay (part 6) lay it flat over the cleaned area ensuring it covers the entire area where the liner will sit. Underlay is very important as it protects your liner bag from puncture or damage and prevents any possible unwanted leaks.

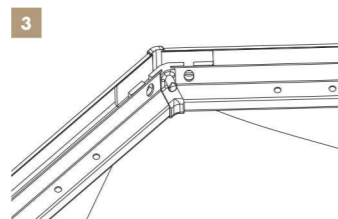

### Step 4

Now using all of the top rails (parts 9, 10 & 11) and all the trident connectors (parts 16 & 17) connect them together into a half-moon shape, each top rail is labelled to help aid you in correct construction. The trident connectors in image 1 allow the top rails to slot into each other, ensure the bottom oval hole is completely free. Image 3 shows the top rail correctly inserted.

The top rails are labelled A, B & C as per image 4.

### Step 5

Using the legs (parts 7 & 8) insert them into the trident connectors as per images 1 and 2. Ensure the end of the leg with the white sticker is not inserted first but are located at the top of the leg once inserted and lined up with the oval holes. The two 90 degree legs fit the 90 degree trident connectors and the 135 degree legs for the 135 degree trident connectors, see the image on step 6 for reference.

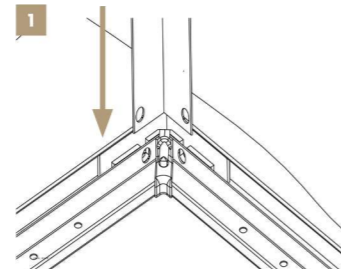

### Step 6

Your Affinity Pool should now have all 6 of the legs inserted the right way up and be ready to have the plastic keys (part 2) inserted at the bottom of the top rails. It should look like the image below with all 6 legs inserted.

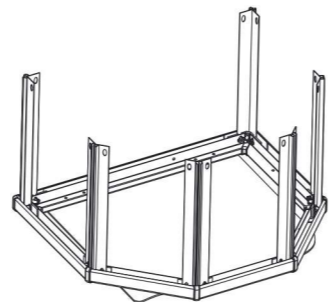

### Step 7

This step requires you to use 12 of the plastic keys (part 2), insert them into each of the oval holes at the base of all the tridents on both sides, 2 per trident. Image 1 shows the first keys being inserted into the oval holes. The oval holes must not be covered but be completely free and open to ensure the keys can fit in easily. Continue to insert all 12 keys.

Now using the supplied tool (part 1) turn the keys a quarter turn so lay flat and lock into position as per image 3. Continue to do this to all 12 keys around the base of the pond until all 6 legs are firmly connected to all 6 trident connectors.

**Note:** the tool has 2 ends to allow for easy tightening of the 90 degree and 135 degree connectors

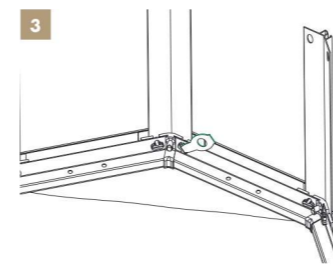
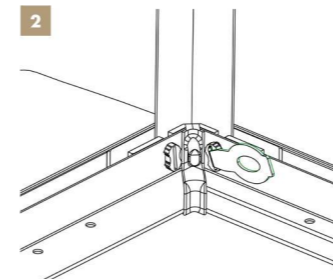
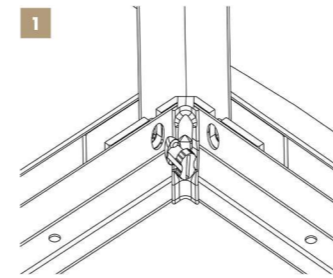

### Step 8

Now would be a good time to look at the exploded diagram and take note of the position of each of the windows on the liner bag (part 5). As all 3 windows are positioned at the front of the half-moon, you must make sure all 3 window panels (part 24) are positioned at the front as per the exploded diagram.

The panels are divided between A, B & C which help guide you on which panel needs to go where.

Identify the window panels first, labelled A (part 24) and slot them into the correct legs, see exploded diagram. You will have to use two hands to ensure it fits easily and correctly between the legs to ensure it fits easily and correctly between the legs the right way by looking at images 1 & 2.

Labels on the panels which have "to the inside" on them means that the side of the panel needs to face towards the inside of the pond.

**Tip:** When sliding the panels into the curved slot sections on the legs ensure the panels are wet with water. This will aid the slotting process of all the panels into the legs.

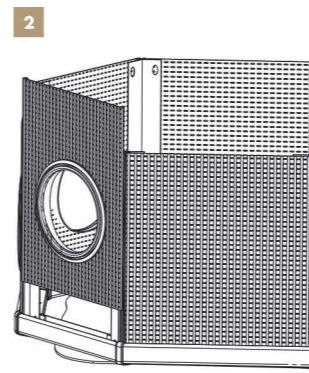
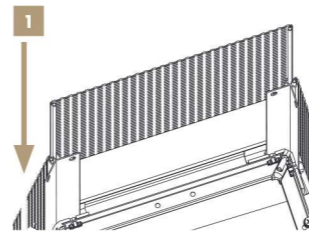

### Step 9

Once all of the panels have been inserted your pool should look like the image below

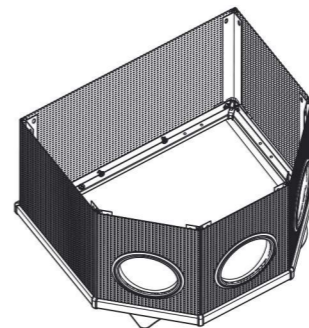

### Step 10

Now using the leg cross brace bars (parts 12, 13 & 14) and 12 of the remaining plastic keys (part 2) insert them one at a time, working your way around the pond leaving one panel empty. Lock the plastic keys by quarter turning them, using the provided tool (part 1).

Once all the leg braces have been inserted and the keys locked the panels of your Affinity Pool should be pulled tight as per image 2 below.

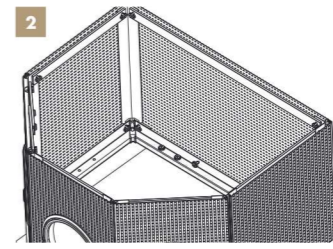
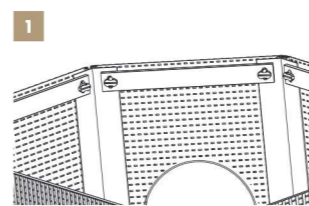

### Step 11

Once the 6 leg cross bracing bars are in position, it is time to insert the tension bar (part 15). Adjust the angle of the bar to match the remaining gap in the frame and insert the remaining two plastic keys (part 2) as per image 1 below. Once the keys are in position lock them with a quarter turn using the provided tool (part 1), then apply pressure to the tension bar to make it straight as per image 2 below. With the bar straight, insert a plant basket fixing pin (part 3) into the remaining empty hole to lock the bar into position as per image 3 below.

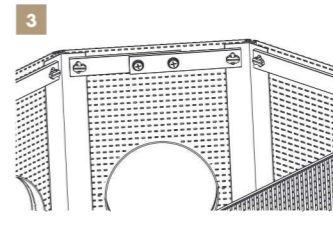
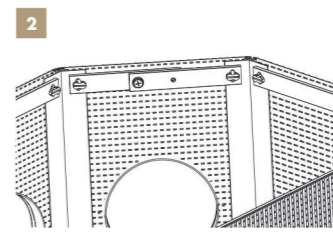
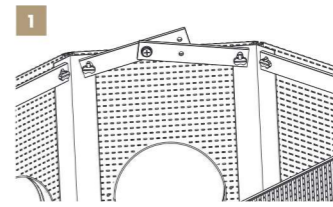

### Step 12

Check all parts are secure and correct and then attach the supplied feet (part 10) to the end of the 7 legs. These clip into place easily and ensure the pond is level and secure. Feet can fit all the 90, 135. See image 1 & 2.

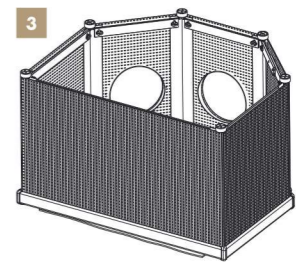
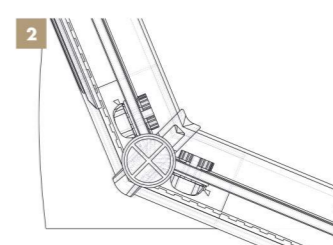
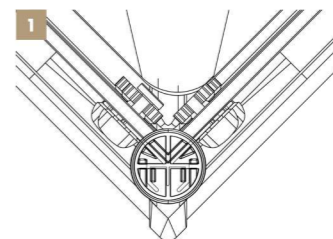

**Important:** Before moving on to step 13, ensure all the labels are removed from the panels, as you will be unable to remove them once the liner bag has been inserted.

### Step 13

Now between two people turn over the Affinity Pool and insert the Liner Bag (Part 5). Place the liner bag inside the Affinity pool and carefully unpack it to fit the inside like in image 4 below. You will see that on image 1 that a hook is present on the trident sections (parts 16 & 17). This enables you to hook each eyelet of the liner to the hook on the trident connector. Ensure the liner is positioned with the windows correctly lined up with the windows on the Mocha Window panels, see exploded diagram for reference.

To be able to hook the liner easily, place the eyelet perpendicular to the top of the hook and slide to the back of the hook before allowing the eyelet to drop down into the groove behind and become secure. Do this to all 6 of the eyelets around the pond. This will leave the 2 eyelets on the back panel empty.

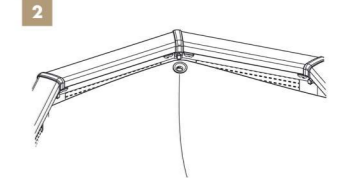
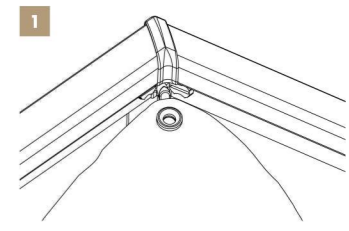

### Step 14

Place the Inpond 5 in 1 filter inside the pond and thread the cable between the liner bag (part 5) and the frame of the pool. Use the section of liner that you left unattached in step 14, this will help to keep the cable tidy and out of harms way. Once the cable has been threaded through the gap, attach the eyelets on the liner bag to the holes on the top rail using 2 of the Plant basket fixing pins (part 3). See Inpond instructions on how to set up the filter correctly, page 12 will help with the installation of the waterfall. Do not turn the Inpond on at this time.

### Step 15

With the Inpond filter in place you can now look at installing the waterfall. To do this clip the Waterfall clips (part 19) onto the top rail either side of the cable for the filter. See image 1 below for reference.

With the clips attached to the rail, next position the waterfall (part 20) so that the bracket on the back of the waterfall sits in the clips, as per image 3 below. Finally attach the waterfall hose (part 21) to the Inpond filter, you may need to cut the hose to length.



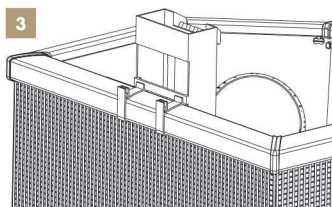
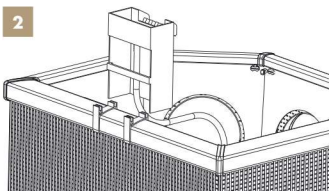
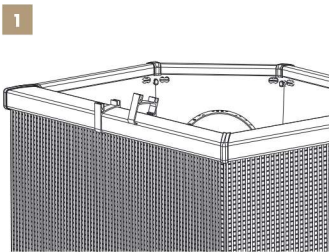

### Step 16

Now the Affinity Pool is in place, the underlay can be neatly folded and tucked under the liner bag. Ensure that it's fitted correctly by slightly lifting up the pond to allow you to fold and push the underlay under the panels and the liner bag. Once this has been done all around the pond, you shouldn't be able to see any of the white underlay.

**Tip:** To help hide the filter cables use the planting basket on the panel where the cables comes through.

### Step 17

One planting basket (Part 18) and two planting basket fixing pins (Part 3) are supplied which can be fitted to panels of the Affinity Pool. Each top rail has two centre holes underneath that allow the planting basket to be pinned in with the fixing pins supplied. The grip of the pin can be adjusted using the inside screw to remove or adjust tightness. If you need to remove a planting basket reverse this process with a cross threaded screwdriver.

Additional baskets are available to purchase individually. Use pond compost to plant your chosen aquatic plants.

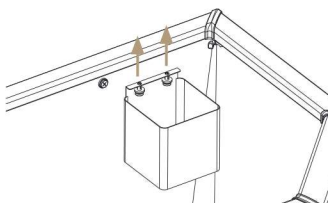

### Step 18

Once everything has been completed and you are completely happy with the position of the pond, you can now fill your Affinity Pool with tap water. Ensure the tap water has been treated with a water dechlorinator as this will ensure it's safe for your fish later. Only fill up to the rings on the liner bag rim, once filled you can turn on your Inpond 5 in 1 filter (please see the filter instructions for correctly installing the pump/filter, using the lighting and water features).

**Important:** Due to the size of your Blagdon View Affinity Pool, we would recommend the use of a Blagdon Affinity Ice Vent Heater over the winter months to help prevent the pool freezing over.

We would recommend, in prolonged spells of temperatures below freezing, to relocate either the fish, or the entire pool to a more sheltered location.

To keep your Affinity Pool windows clean, use **ONLY** the Affinity anti-scratch window cleaning pads code 1051200. Any other material may scratch or damage the windows. Polymer wool pads supplied are for the Inpond all-in-one filter, (see instruction manual).

All these items are available as replacements from your retailer.

For further information, see our website: [www.affinitypools.co.uk](http://www.affinitypools.co.uk)

## Guarantee

This product is guaranteed against defects in material and workmanship for 3 years from the date of purchase, under normal usage. The guarantee DOES NOT APPLY in case of improper use, negligence, lack of maintenance or accidental damage to the Affinity Pool. If the Affinity Pool fails due to a manufacturing fault within this period it will be either repaired or replaced free of charge. Liability is limited to replacement of the faulty product only; no other costs will be reimbursed.

This guarantee is not transferable and does not affect your statutory rights. This guarantee does not confer any rights other than those expressly set out above. Excludes consumable parts (pump Impellor, LED light & UVC lamp). If any parts are needed, spares are available from your retailer. Please see the Inpond 1400 instructions for more information and part descriptions.



### Environment Friendly Disposal

You can help protect the environment! Please remember to respect the local regulations and hand in any non-working electrical equipment to an appropriate waste disposal centre.

## Consumer Advice Contact Information

Interpet (Blagdon) Consumer Advice Department,  
Vincent Lane, Dorking, Surrey RH4 3YX

**Fax:** 01306 876712 **E-mail:** [customercare@interpet.co.uk](mailto:customercare@interpet.co.uk)

[www.affinitypools.co.uk](http://www.affinitypools.co.uk)

**IMPORTANT: PLEASE ATTACH PROOF OF PURCHASE TO THIS MANUAL AND FILE IN A SAFE PLACE.**



Affinity feature pools have been designed by a leading British water gardening company. Over half a century of fish keeping and water gardening knowledge is brought together in this product, so you can be assured of a successful, creative water feature.