



affinity[®]
living feature pools

view octagon

mocha weave & black aluminium
instructions



HOW TO
BUILD YOUR
AFFINITY VIEW
SEE WEBSITE

www.affinitypools.co.uk
www.pondaquariumproblemsolver.co.uk/blagdon

To keep your Affinity Pool windows clean, use **ONLY** the Affinity anti-scratch window cleaning pads code 1051200. Any other material may scratch or damage the windows. Polymer wool pads supplied are for the Inpond all-in-one filter, (see instruction manual).

All these items are available as replacements from your retailer.

For further information, see our website: www.affinitypools.co.uk

Guarantee

This product is guaranteed against defects in material and workmanship for 3 years from the date of purchase, under normal usage. The guarantee DOES NOT APPLY in case of improper use, negligence, lack of maintenance or accidental damage to the Affinity Pool. If the Affinity Pool fails due to a manufacturing fault within this period it will be either repaired or replaced free of charge. Liability is limited to replacement of the faulty product only; no other costs will be reimbursed.

This guarantee is not transferable and does not affect your statutory rights. This guarantee does not confer any rights other than those expressly set out above. Excludes consumable parts (pump Impellor, LED light & UVC lamp). If any parts are needed, spares are available from your retailer. Please see the Inpond 1400 instructions for more information and part descriptions.



Environment Friendly Disposal

You can help protect the environment! Please remember to respect the local regulations and hand in any non-working electrical equipment to an appropriate waste disposal centre.

Consumer Advice Contact Information

Interpet (Blagdon) Consumer Advice Department,
Vincent Lane, Dorking, Surrey RH4 3YX
Fax: 01306 876712 E-mail: customer-care@interpet.co.uk
www.affinitypools.co.uk

IMPORTANT: PLEASE ATTACH PROOF OF PURCHASE TO THIS MANUAL AND FILE IN A SAFE PLACE.



Affinity feature pools have been designed by a leading British water gardening company. Over half a century of fish keeping and water gardening knowledge is brought together in this product, so you can be assured of a successful, creative water feature.

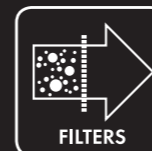

View Octagon Assembly Instructions

Getting to know your Affinity living feature pool

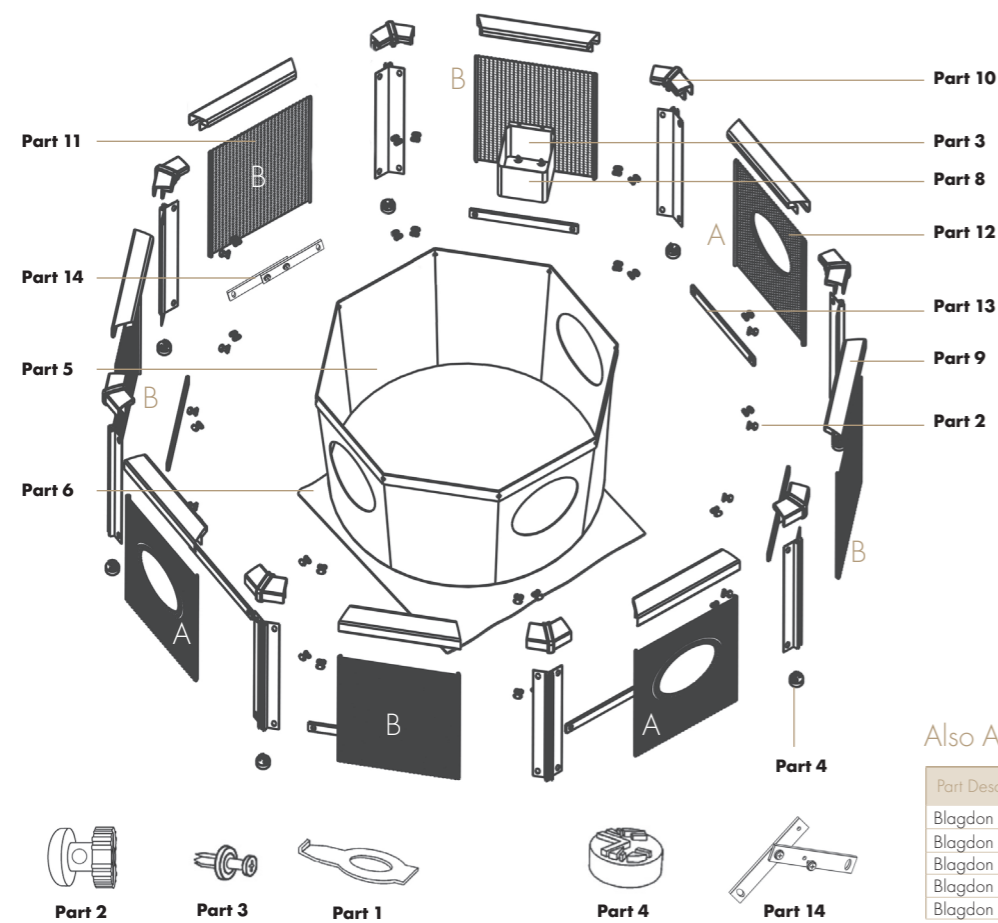

Part List

Part Description	Quantity	Part No.
Tool	1	1
Plastic key	32	2
Planting basket fixing pin	4	3
Leg feet	8	4
Octagon liner	1	5
Underlay	1	6
135 Degree legs	8	7
Planting basket	1	8
Top rail	8	9
Trident connector	8	10
Mocha weave panel	5	11
Mocha weave window panel	3	12
Leg cross brace	7	13
Tension bar	1	14

Technical specifications
 37 gallons 29.7" w x 29.7" d x 18.1"
 141 ltr 75.5cm w x 75.5cm d x 46cm

Also Available

Part Description	Product Code
Blagdon Affinity Ice Vent Heater	1051545
Blagdon Affinity Plant Basket	1052245
Blagdon Inpond 2000 Maintenance Kit	1054690
Blagdon Affinity View Octagon Replacement Liner	1055703
Blagdon Affinity Green Water Clarifier	1051309

Step by Step Guide

Step 1

Please remove all of the relevant parts from the packaging and double check that all of the items are there (use the complete parts list and exploded diagrams to check this)

Step 2

Identify a suitable area where your Affinity Pool can be placed, ensure that the area is level with a firm base and is free from stones or any other debris that could damage your liner bag.

Step 3

Using your supplied underlay (part 6) lay it flat over the cleaned area ensuring it covers the entire area where the liner will sit. Underlay is a protective material that prolongs the life of your liner and stops any possible unwanted leaks in the future.

Step 4

Now using the top rails (part 9) and the trident connectors (part 10) connect them together in an octagon shape, each top rail is labelled either A or B and needs to be inline with image 1 below.

The trident connectors in image 2 allow the top rails to slot into each other easily, ensure the bottom oval hole is completely free.

At the end of this step all 8 tridents and top rails should be slotted together as in the image on step 5.

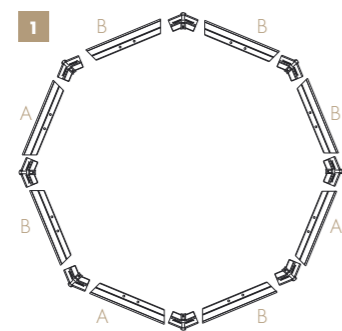

2 Line up and push fit together

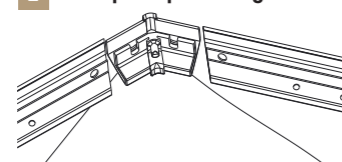

Step 5

Your top rails and tridents should look like the image below and should be ready to insert the 135 degree legs (part 7) as per step 6.

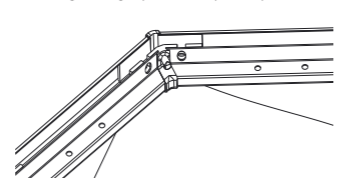

Step 6

Using the legs (part 7) insert them into each of the trident connectors (part 10) as per images 1 & 2. Ensure the end of the leg with the white sticker is not inserted first but are located at the top of the leg once inserted and lined up with the oval holes. Continue to do this to all 8 tridents and all 8 legs provided

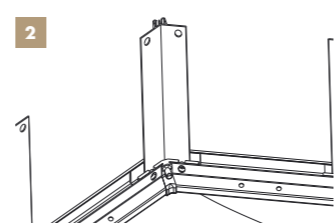
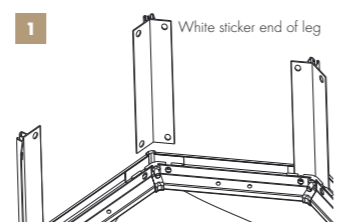

Step 7

Your Affinity Pool should now have all 8 of the legs (part 7) inserted the right way up and be ready to have the plastic keys (part 2) inserted at the bottom of the top rails (part 9). It should look like the image below with all 8 legs inserted.

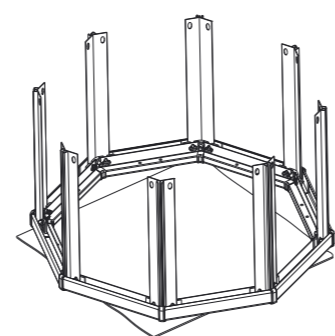

Step 8

This step requires you to use exactly 16 of the plastic keys (part 2). Insert them into each of the oval holes at the base of the tridents (part 10) on both sides. Image 1 shows the first keys being inserted into the oval holes. As previously stated in step 4, the oval holes must not be covered, but be completely free and open to ensure the keys can fit in easily. Continue to insert all 16 keys.

Now using the supplied tool (part 1) turn the keys a quarter turn so they lay flat and lock into position as per image 2. Continue to do this to all 16 keys around the base of the pond until all 8 legs are firmly connected to all 8 of the trident connectors.

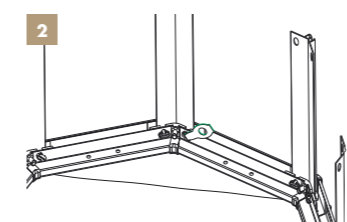
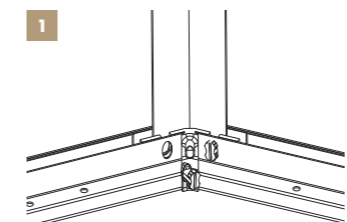

Step 9

Now would be a good time to look at the exploded diagram and take note of the position of each of the windows on the liner bag (part 5). The windows on the liner bag will dictate where the Mocha Weave panels can be inserted into the legs (part 7). The Mocha Weave panels are divided between A and B and help guide you on which panel needs to go where. Identify the non window panels first, labelled B (part 11) and slot them into the correct legs, see exploded diagram and step 10 for reference. You will have to use two hands and slot both sides of the panel at the same time to ensure it fits easily and correctly between the legs to the bottom rail.

The correct legs will be dependant on the bottom rail which will be labelled B. Image 1 shows how to slot the panel into the leg section, ensure the panel is facing the correct way before inserting by taking note of the label on the panel.

Labels on the panels which have "to the inside" on them means the side of the panel that needs to face inwards when slotting them into place.

Tip: When sliding the panels into the curved slot sections on the 135 Degree legs ensure the panels are wet with water. This will aid the slotting process of all the panels into the legs.

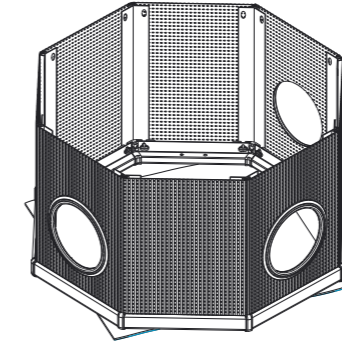
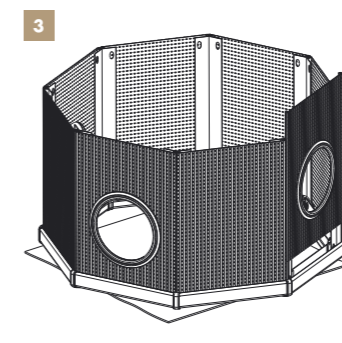
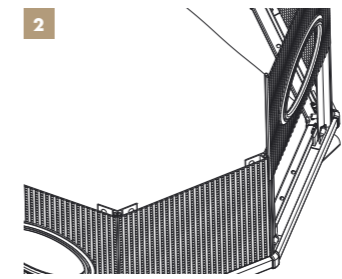
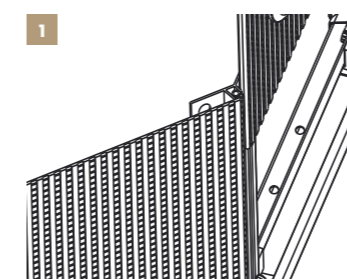

Step 10

Now the window panels (part 10) can be inserted into the remaining empty sections on the Affinity Pool frame. Image 1 show that the window panels must be inserted with the window frames facing outwards and be slotted into the legs that way down with the window closer to the top rail (part 9). Image 2 shows that the window panels need to be slotted in this way to ensure it matches up with the window on the liner bag (part 5) later.

Labels on the panels which have "to the inside" on them means the side of the panel that needs to face inwards when slotting them into place.

Step 11

Now using the leg cross brace bars (part 13) and 14 of the remaining plastic keys (part 2) insert them one at a time, working your way around the pond leaving one panel empty. Lock the plastic keys by quarter turning them, using the provided tool (part 1), as per the image below.

Once all the leg braces have been inserted and the keys locked the panels of your Affinity Pool should be pulled tight.

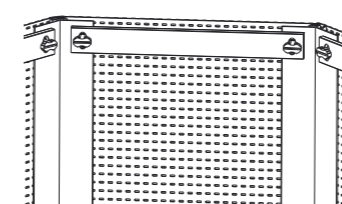

Step 12

Once the 7 leg cross bracing bars are in position, it is time to insert the tension bar (part 14). Adjust the angle of the bar to match the remaining gap in the frame and insert the remaining two plastic keys (part 2) and tighten them with a quarter turn, as per image 1 below. Once the keys are in position apply pressure to the tension bar to make it straight as per image 2 below. With the bar straight, insert a plant basket fixing pin (part 3) into the remaining empty hole to lock the bar into position as per image 3 below.

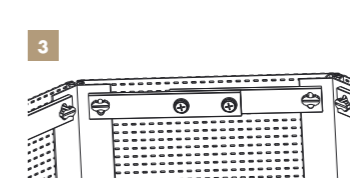
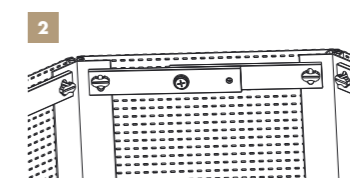
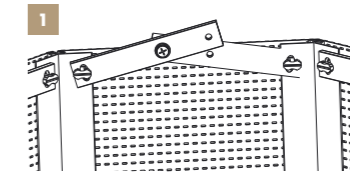

Step 13

Check all parts are secure and correct and then attach the supplied feet (part 4) to the end of the 8 legs (part 7). These clip into place easily and ensure the pond is level and secure.

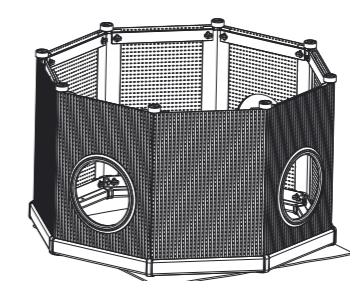
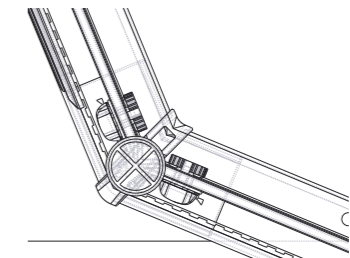

Step 14

Now between two people turn over the Affinity Pool and Insert the Liner Bag (Part 5). Place the liner Bag inside the Affinity pool and carefully unpack it to fit the inside. You will see that a hook is present on the trident section (part 10). This enables you to hook each eyelet of the liner to the hook on the trident connector. Ensure the liner is positioned with the windows correctly lined up with the windows on the Mocha Window panels, see exploded diagram and image on step 10 for reference.

To be able to hook the liner easily, place the eyelet perpendicular to the top of the hook and slide to the back of the hook before allowing the eyelet to drop down into the groove behind and become secure as shown in the image below. Continue to do this to 7 of the eyelets around the pond but keep one unhooked.

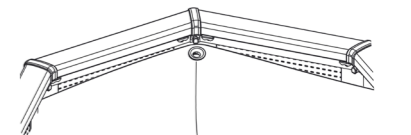

Step 15

Place the Inpond 5 in 1 filter inside the pond and thread the cable between the liner bag (part 5) and the frame of the pool. Use the section of liner that you left unhooked in step 15, this will help to keep the cable tidy and out of harms way. Once the cable has been threaded through the gap, attach the eyelet on the liner bag to the remaining hook as per step 15. See Inpond instructions on how to set up the filter correctly, page 10 of the instructions will help with the installation of the fountain. Do not turn the Inpond on at this time.

Step 16

Now the Affinity Pool is in place, the underlay can be neatly folded and tucked under the liner bag. Ensure that it's fitted correctly by slightly lifting up the pond to allow you to fold and push the underlay under the panels and the liner bag. Once this has been done all around the pond, you shouldn't be able to see any of the white underlay.

Step 17

One planting basket (part 8) and two planting basket fixing pins (part 3) are supplied which allows you to have a plant basket on any panel of the Affinity Pool. Each top rail has two centre holes underneath that allow the planting basket to be pinned in with the fixing pins supplied. The grip of the pin can be adjusted using the inside screw to remove or adjust tightness. If you need to remove a planting basket reverse this process with a cross threaded screwdriver.

Additional baskets are available to purchase individually. Use pond compost to plant your chosen aquatic plants.

Tip: To help hide the filter cables use the planting basket on the panel where the cables come through.

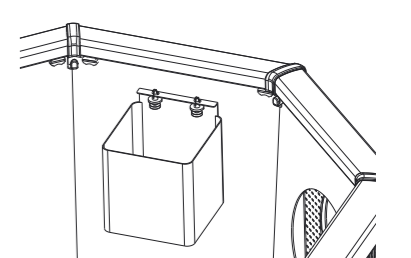

Step 18

Once everything has been completed and you are completely happy with the position of the pond, you can now fill your Affinity Pool with tap water. Ensure the top water has been treated with a water dechlorinator as this will ensure it's safe for your fish later. Only fill up to the rings on the liner bag rim, once filled you can turn on your Inpond 5 in 1 filter (please see the filter instructions for correctly installing the pump/filter, using the lighting and water features).

Important: Due to the size of your Blagdon View Affinity Pool, we would recommend the use of a Blagdon Affinity Ice Vent Heater over the winter months to help prevent the pool freezing over.

We would recommend, in prolonged spells of temperatures below freezing, to relocate either the fish, or the entire pool to a more sheltered location.