



inpond 5 in 1

3000 • 6000

waterfall 6 in 1

9000

www.interpet.co.uk
www.blagdonwatergardening.co.uk



inpond

3000 • 6000 • 9000

Congratulations on buying an inpond 5 in 1

Manufactured with advanced technology to create a clean and healthy pond for your fish.

IMPORTANT

Please attach proof of purchase to this manual and file in a safe place.

CONTENTS

Getting to know your Inpond 3000.....	2
Parts Descriptions / spares codes - with exploded diagram.....	2, 3 & 4
Getting to know your Inpond 6000/9000.....	5
Parts Descriptions / spares codes - with exploded diagram.....	5, 6 & 7
Pump performance / flow chart	7
Specification chart.....	8
Installation	9
Electrical Installation	9
Installing Inpond	10, 11, 12, 13, 14 15
Installing UVC	18 - 19
UVC Electrical Installation.....	20 - 21
Maintenance and cleaning	17, 18 - 23
Cleaning	23 - 24
Step by Step guides	18
Routine Maintenance.....	18
Annual Maintenance	24
Winter storage	24
Troubleshooting	25
Troubleshooting and maximise performance	25, 26 & 27
Faults - problem procedure	27
Consumer advice contact details	28
Guarantee	27 & 28

GETTING TO KNOW YOUR INPOND 3000

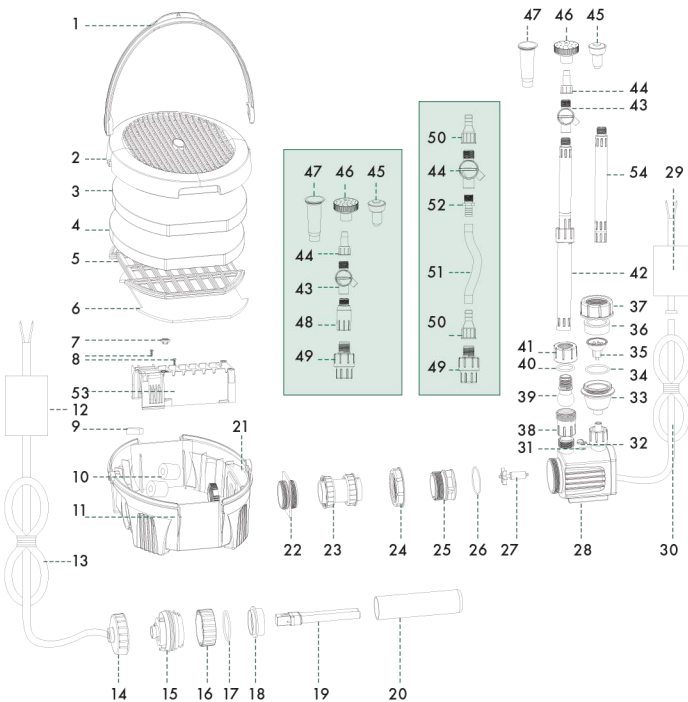

GETTING TO KNOW YOUR INPOND 3000

No.	Part Description	Spare Code
1.	Locking Handle	N/A
2.	Filter Lid	N/A
3.	Coarse Foam	1051170
4.	Medium Foam	1051170
5.	Polymer Wool Cartridge	N/A
6.	Polymer Wool Pad	1051166
7.	UVC Viewing Window	N/A
8.	UVC Contact Chamber Screws	N/A
9.	UVC Magnet	N/A
10.	Ceramic Media	1051187
11.	Filter Body	N/A
12.	IPX7 Starter UVC	N/A
13.	UVC Mains Cable	N/A
14.	UVC Electronics & Cap	N/A
15.	UVC Body	N/A
16.	UVC Quartz Sleeve Yellow Lock Cap	N/A
17.	UVC O ring	N/A
18.	UVC Quartz sleeve Holder	N/A
19.	PL 5w UVC Lamp	1041041
20.	5w Quartz Sleeve	N/A
21.	Outlet Locking Nut	N/A
22.	Double threaded attachment	N/A
23.	1 1/2" Connecting Pipe	N/A
24.	Pump Locking Nut	N/A
25.	1 1/2" Impellor Cover	N/A
26.	O ring	N/A
27.	Impellor Complete	1017800
28.	Pump motor unit	N/A
29.	Low Voltage Transformer	N/A
30.	Pump Cable Low Voltage	N/A
31.	Light Level Sensor - Photo Sensor	N/A
32.	Optional Sensor Cover	N/A
33.	Automatic LED Spot Light Body	N/A
34.	Automatic LED Spot Light O ring	N/A
35.	LED Lamp 0.76w	1051330
36.	LED Lamp cover clear	N/A
37.	LED Lamp Screw Cap	N/A

GETTING TO KNOW YOUR INPOND 3000

GETTING TO KNOW YOUR INPOND 6000 / 9000

No.	Part Description	Spare Code
38.	Ball Joint Connector	N/A
39.	Ball Joint	N/A
40.	Ball Joint O ring	N/A
41.	Extension Pipe Connector	N/A
42.	30cm Telescopic Extension pipe	N/A
43.	Control Valve & Diverter	N/A
44.	Screw on hosesails 1/2" 12.5mm	N/A
45.	Daisy	1017763
46.	Super Daisy	1017763
47.	Water Bell Large	1017763
48.	New Fountain Adapter	N/A
49.	Complete Ball Joint	N/A
50.	Screw on hosesails 1/2" 12.5mm	N/A
51.	1/2" 12.5mm Silicon Hose; not included	N/A
52.	1/2" 12.5mm Control Valve hose attachment	N/A
53.	UVC Contact Chamber	N/A
54.	20cm Extension Pipe	N/A

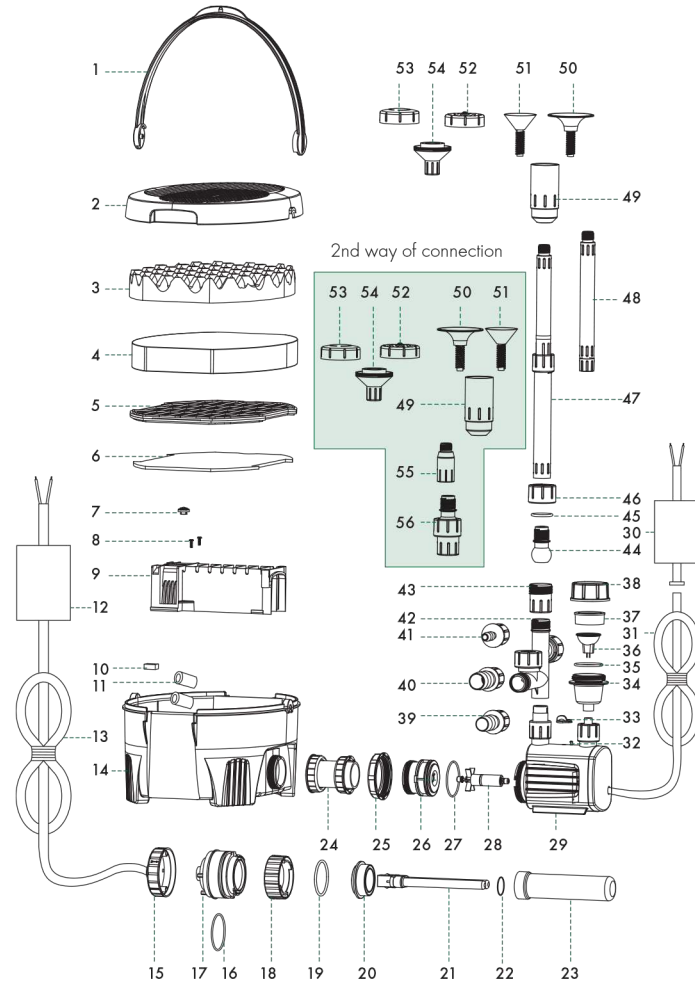

GETTING TO KNOW YOUR INPOND 6000 / 9000

No.	Part Description	Spare Code
1.	Locking Handle	N/A
2.	Filter Lid	N/A
3.	Coarse Foam	1051774
4.	Medium Foam	1051774
5.	Polymer Wool Cartridge	N/A
6.	Polymer Wool Pad	1051166
7.	UVC Viewing Window	N/A
8.	UVC Contact Chamber Screws	N/A
9.	UVC Contact Chamber	N/A
10.	UVC Magnet	N/A
11.	Ceramic Media	N/A
12.	IPX7 Starter UVC	N/A
13.	UVC Mains Cable	N/A
14.	Filter Body	N/A
15.	UVC Electronics & Cap	N/A
16.	UVC O ring	N/A
17.	UVC Body	N/A
18.	UVC Quartz Sleeve Yellow Lock Cap	N/A
19.	UVC Quartz sleeve O ring	N/A
20.	UVC Quartz sleeve Holder	N/A
21.	PL 9w UVC Lamp	N/A
22.	Lamp Rubber Holder	N/A
23.	9w Quartz Sleeve	N/A
24.	1 1/2" Connecting Pipe	N/A
25.	Pump Locking Nut	N/A
26.	1 1/2" Impellor Cover	N/A
27.	Pump O ring	N/A
28.	Inpond 6000 Impellor Complete	1051781
	Inpond 9000 Impellor Complete	1050333
29.	Inpond 6000 Pump motor unit	N/A
	Inpond 9000 Pump motor unit	N/A
30.	Inpond 6000 Low Voltage Transformer	N/A
31.	Pump Cable Low Voltage	N/A
32.	Light Level Sensor - Photo Sensor	N/A
33.	Optional Sensor Cover	N/A
34.	Automatic LED Spot Light Body	N/A
35.	Automatic LED Spot Light O ring	N/A

GETTING TO KNOW YOUR INPOND 6000 / 9000

No.	Part Description	Spare Code
36.	LED Lamp 0.76w	1051330
37.	LED Lamp cover clear	N/A
38.	LED Lamp Screw Cap	N/A
39.	18.75mm (3/4") Hose Fitting	N/A
40.	25mm (1") Hose Fitting	N/A
41.	12.5mm (1/2") Hose Fitting	N/A
42.	Inpond 6000 T-piece	N/A
	Inpond 9000 T-piece	N/A
43.	T-piece Connector	N/A
44.	Ball Joint	N/A
45.	Ball Joint O ring	N/A
46.	Extension Pipe Connector	N/A
47.	30cm Telescopic Extension pipe	N/A
48.	20cm Extension pipe	N/A
49.	Jet Housing	N/A
50.	Bell Jet	N/A
51.	Tulip Jet	N/A
52.	Daisy jet	N/A
53.	Triple Jet	N/A
54.	Jet Housing	N/A
55.	Fountain adapter	N/A
56.	Complete Ball Joint	N/A

Pump performance / flow chart

1.5m	79 ltr/hr	200 ltr/hr	835 ltr/hr
1.0m	300 ltr/hr	870 ltr/hr	1626 ltr/hr
0.5m	520 ltr/hr	1250 ltr/hr	2371 ltr/hr
0m	700 ltr/hr	1500 ltr/hr	3000 ltr/hr
MODEL	3000	6000	9000







Technical data - Pump

Pump	3000	6000	9000
Max Flow	700	1500	3000
Max Head	1.25m	1.3m	2.0m
Voltage	12V	12V	230V
Hertz	50Hz	50Hz	50Hz
Weatherproof transformer	IP68	IP68	IP68
CE Approved	CE Approved	CE Approved	CE Approved
Cable	10m	10m	10m
Watts	10w	26.5w	49.5w

Technical data - UVC

Pump	3000	6000	9000
Voltage	230 Volt	230 Volt	230 Volt
Hertz	50Hz	50Hz	50Hz
UVC Lamp	5 Watt	9 Watt	9 Watt
Weatherproof transformer	IP68	IP68	IP68
CE Approved	CE Approved	CE Approved	CE Approved
Cable	10m	10m	10m

Specification chart

Model & Pond Size Category	 Deep without fish	 Deep with fish	 Shallow with fish	 Deep with fish in full sun	 Shallow with fish in full sun	 Shallow with Koi in full sun	Filter & Waterfall	Fountain, Filter & Waterfall
3000 STANDARD POND	3000 ltrs 660 gals	2000 ltrs 440 gals	1500 ltrs 330 gals	1500 ltrs 330 gals	1125 ltrs 247 gals	562 ltrs 123 gals	N/A	N/A
6000 MEDIUM POND	6000 ltrs 1320 gals	4000 ltrs 880 gals	3000 ltrs 660 gals	3000 ltrs 660 gals	2250 ltrs 495 gals	1125 ltrs 247 gals	N/A	N/A
9000 LARGE POND	9000 ltrs 1980 gals	6000 ltrs 1320 gals	4500 ltrs 990 gals	4500 ltrs 990 gals	3375 ltrs 742 gals	1687 ltrs 371 gals	14cm (5.5") 2685 ltrs 590 gals	10cm (3.9") 1879 ltrs 413 gals

"The power supply must meet the specification of the product.

Inpond Pump

The cores in the supply cable are coloured in accordance with the following code:
Brown = Live, Blue = Neutral.

The electric cable is permanently connected and sealed in the motor body.
 If the supply cable is damaged the pump must not be used.

Do not use the supply cable to lift the pump as this may cause damage.



WARNING - All Inpond models must be used with an RCD
 A Residual Current Device (RCD), also know as the Residual Current Circuit Breaker (RCCB), with a tripping current not exceeding 30mA must be installed in the supply circuit.

A means of disconnection from the supply having a contact separation of at least 3mm in all poles must be incorporated in the fixed wiring.

For permanent installations to the mains supply, it is necessary to conform to the regulations of the local electricity authority and this would include the use of a metal or plastic conduit to protect the cable.

Attention has been drawn to the fact that special rules may exist concerning the installation of your pond pump (i.e. local building regulations).

These pumps must not be used in swimming pools, or areas where people are in contact with the water.

Always disconnect the mains electricity supply whilst the equipment is being installed, repaired, maintained or handled. Consult a qualified electrician if in any doubt about wiring this product to the main supply.



Warning - The Inpond pump is provided with a thermal cut out that temporarily switches off the pump in case of overheating and the pump may automatically restart.

Locating your Inpond

The Inpond pump and filter should be located on a firm and level base in the pond/water feature in a depth of at least 10cm, but no more than 1.25m for the 3000 model and 1.5m for the 6000/9000 models.

Fountain

Make sure there is ample cable from the transformer. Place product in desired location. Using the telescopic pipe adjust so the fountain head is above the surface of the pond.

Fountain height can now be adjusted, see 'Adjusting flow control' diagram below. See "Getting to know your Inpond" for parts and descriptions.

Inpond 3000

Adjusting Flow Control

Turn clockwise to increase anti-clockwise to reduce flow.

The flow control valve is fitted with a diverter to ensure there is always pond circulation.



Bell Fountain

Adjust bell by moving head higher for small bell and lower for a wider bell shape.

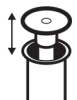

Inpond 6000/9000

Adjusting Dual Control T Piece and telescopic riser pipe

1. Adjust height by unlocking collar then pushing or pulling 30cm telescopic riser pipe. Optional additional 20cm extensions can be added to increase the height.

2. Outlet Flow Control Valve

Supply water features, waterfalls and filters by adding 1" 3/4" 1/2" fittings and hose. Adjust flow by turning flow control valve.

3. Fountain Flow Control Valve

Adjust fountain jet flow by turning flow control valve.

4. Fountain Ball Joint

Adjust the collar of the ball joint to enable the extensions to be moved compensating for an uneven pond floor.

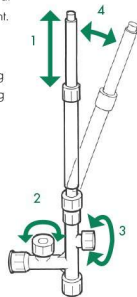

Tip: Ensure that any fountain or feature fitted does not empty water out of pond/water feature.

Convenient Installation

Installation guide: Inpond 3000

The inpond 5 in 1 can be installed either powering a fountain or feature.

FOUNTAIN OPTION

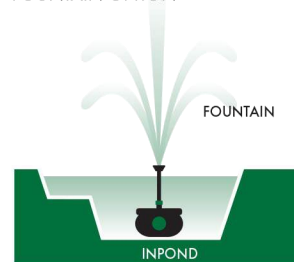

FEATURE OPTION

OR

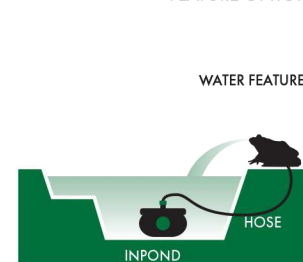

Installation guide: Inpond 6000

The inpond 5 in 1 can be installed either powering a fountain or feature, or both.

INPOND, FOUNTAIN AND/OR FEATURE OPTION

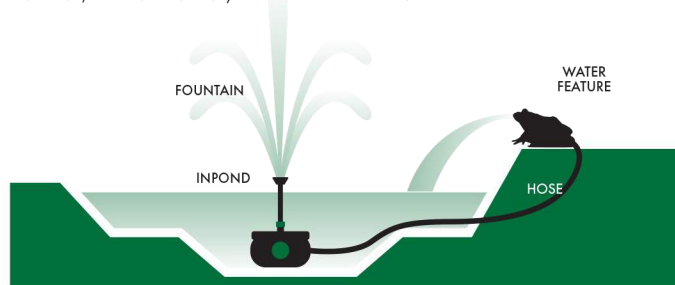

Installation guide: Inpond 9000

The waterfall inpond can be installed either powering a fountain, a waterfall or both.

FOUNTAIN OPTION

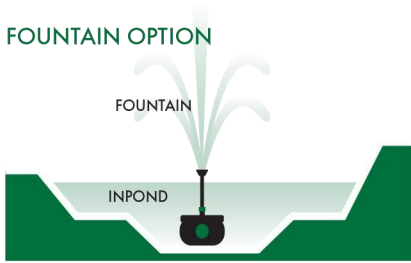

WATERFALL OPTION

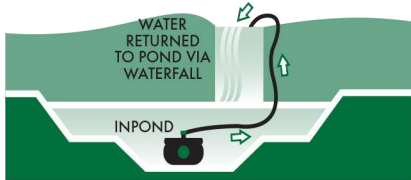

FOUNTAIN & WATERFALL OPTION

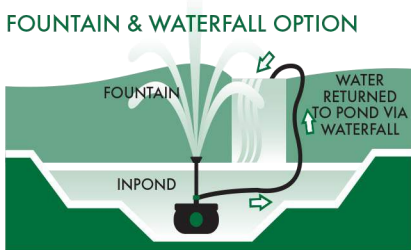

Inpond 3000

INPOND 5 IN 1 RUNS A FOUNTAIN OR FEATURE AND LED SPOTLIGHT

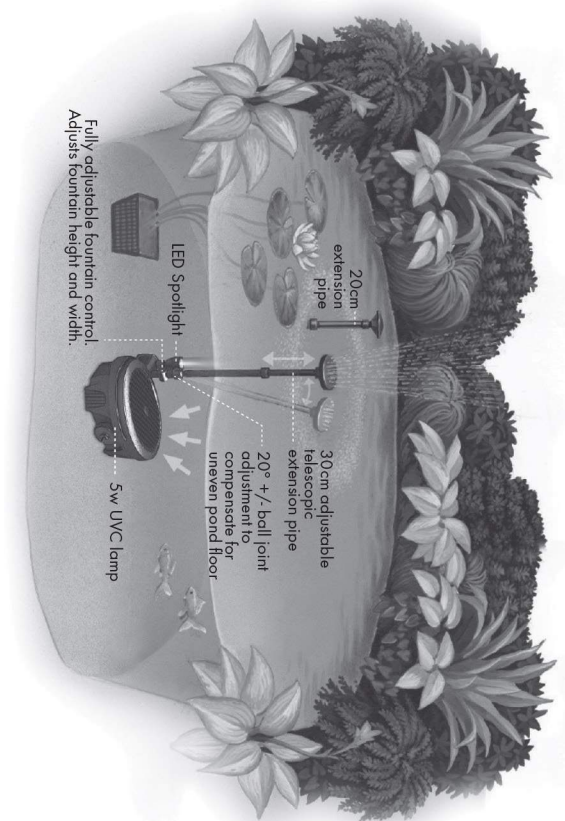

Inpond 6000

INPOND 5 IN 1 RUNS A FOUNTAIN AND/OR FEATURE AND LED SPOTLIGHT

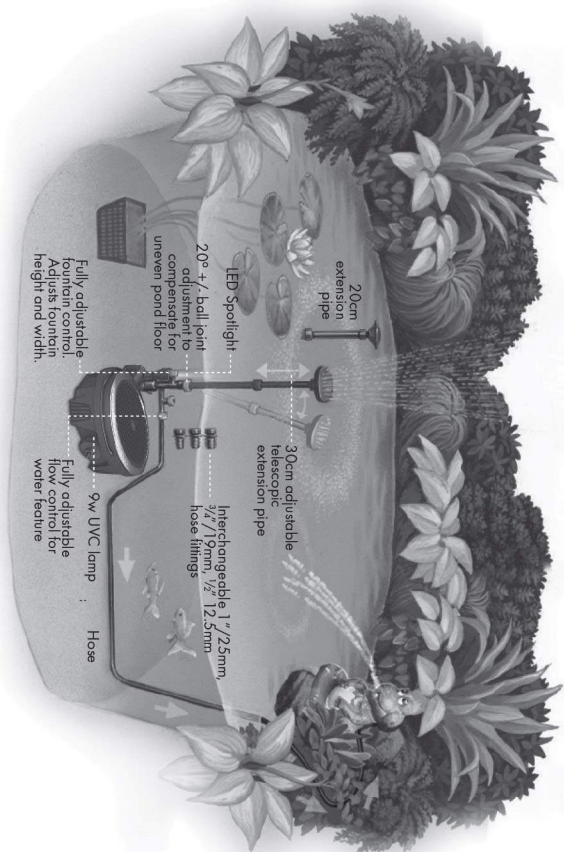

Inpond 9000

TO RUN WATERFALLS/FEATURES AND/OR A FOUNTAIN AND LED SPOTLIGHT

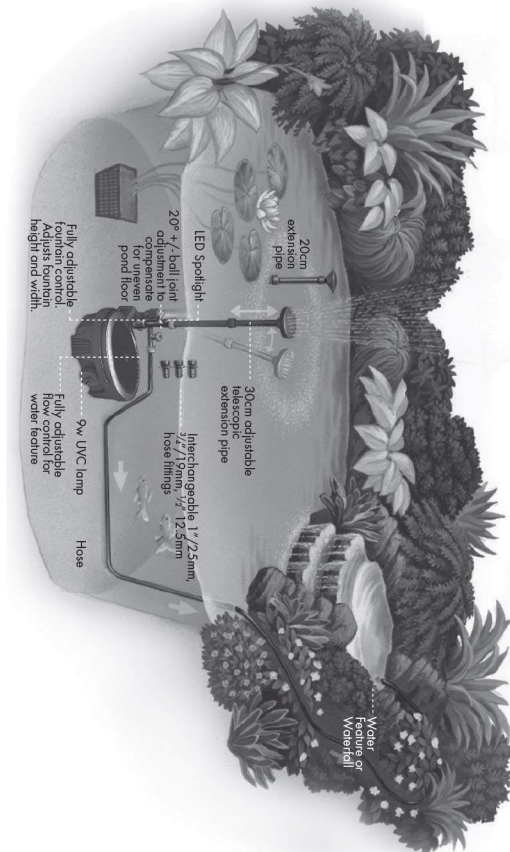

Waterfall Installation

Important

The outlet hose should be smooth bore (not corrugated) pipe installed over as short a distance as possible with no kinks or bends.

Connecting Outlet Hoses

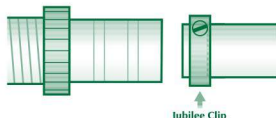

The recommended hose size for your Inpond Filter is stated in the filter performance and specification chart. On Page 8

Always secure with a Jubilee clip

Warming the hose in a bucket of boiling water can aid fitting.

Use the shortest possible hose lengths to minimise flow restrictions.

Avoid folds and kinks in the hose, which will reduce flow and filter performance.

Installing the waterfall or feature

3000

6000/9000

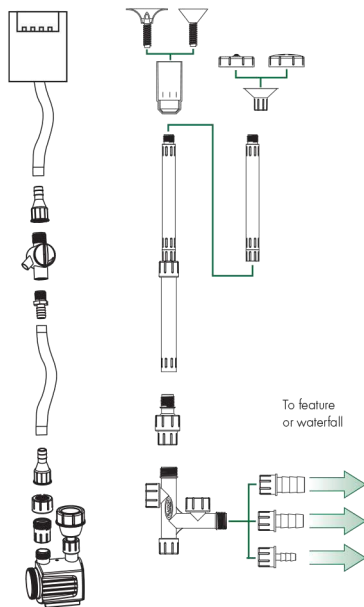

IMPORTANT - Failure to carry out routine maintenance leaving the pump under reduced or no flow conditions for long periods will result in a shorter pump life and will invalidate the guarantee.

The Blagdon Inpond 5 in 1 is centrifugal with a magnetic impellor movement driven by a watertight synchronous motor. They require minimum cleaning, only periodic cleaning of the impellor is necessary.

Routine Maintenance

1. Switch off electricity
2. Remove Inpond from pond using carry handle (do not use the cables to lift the Inpond)

How it works - Flow detail

The water flows through the top of the filter cage down through the filter foams and ceramic media then through the UV chamber ready to exit via the pump.

Locking Handle

Doubles as a carry handle for easy removal from pond

Inlet Grills

High surface area, ideal for general pond use

Course/Medium Foam

Open cell foam in two reducing grades catching dead algae, dirt and waste giving a crystal clear pond.

Green Water UV Clarifier

Built in light guarantees algae free clear water

Safety Switch

Built in automatic magnetic safety OFF switch for the UV

Automatic LED Spotlight

Saving time and money

Pump

Polymer Wool Pad Cartridge

Polishes the water quickly removing particles that create cloudiness

Ceramic Biomeia

Supports large populations of friendly bacteria, creating a clear and healthy pond

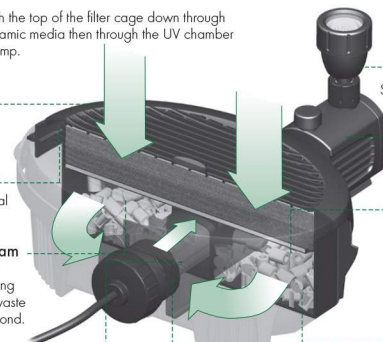

Opening and locking filter handle

Easy lift integrated locking handle



1. Handle in the locked position



2. Handle is in the central position. This will enable the filter and pump to be carried in and out of the pond. *Ensure the filter is not carried by the pump cable.



3. Close handle down to open position



4. The handle is in the unlocked position allowing the filter media to be removed and cleaned.

Foams may be cleaned vigorously in a bucket of pond water.

Adding Blagdon Bio Start after filter maintenance will help replenish these beneficial bacterial populations and is highly recommended during the first two months of operation when the filter is slowly being colonised.

Ceramic bio media

These will only need very occasional cleaning (once per year), but must be rinsed in pond water to prevent damaging the beneficial bacteria which help maintain a healthy pond.



Warning - 1) Always turn off the power before any maintenance to the UVC section 2) Always view the UVC lamp through the viewing window on the UVC Chamber 3) Direct exposure to UVC light can damage your eyes and skin.



Caution - Inpond UVC has been fitted with a magnetic safety switch. 1) Do not remove unit with power turned on 2) Do not place near strong magnetic fields.

UVC Lamps & quartz sleeve maintenance

The UVC lamp must be replaced every six months / once a season. It is recommended that the lamp is replaced in the spring.

The Quartz sleeve can become coated in lime scale build up in hard water areas. This should be carefully removed from the quartz sleeve and cleaned with a soft cloth.

A wet test must be carried out after maintenance to ensure there are no leaks before the UVC is reconnected, pond/water feature.

Wet testing the UVC

IMPORTANT - A wet test of the UVC under operating conditions must be carried out before the UVC or electrical supply is installed. Connect the UVC to the Inpond following all installation instructions. After running for 24 hours check for leaks.

Testing/replacing the UVC lamp

IMPORTANT - Ensure that the mains supply is switched off and the power is isolated before removing the UVC cover.

See Page 19 for illustration

1. Unlock the green UVC electronics cap.
2. Inspect the UVC cap and Quartz sleeve for water leaks.
3. Then unlock the yellow quartz sleeve end cap and unplug the lamp to replace if desired

UVC INSTALLATION

- If there are no signs of leakage reverse the procedure ensuring that the quartz sleeve O-ring is in place. See alignment diagram.
- Ensure the yellow quartz sleeve cap and the green UVC electronics cap are firmly secured by making sure the two looked positions are in direct line of each other. See diagram on page 18, section 5.
- The unit is protected by a magnetic safety switch that prevents the UVC light from illuminating when the cover is removed even if the power is on.
- In order to check that the UVC lamp is operating see page 23 on how to view your UVC lamp.

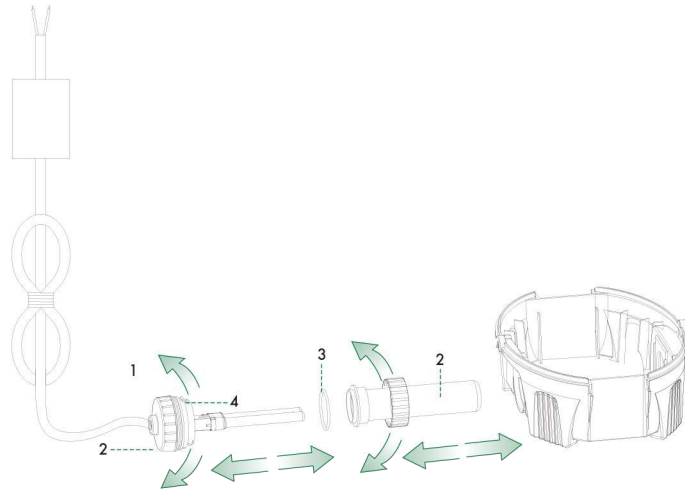

If there has been any damage to the unit please return to the point of purchase for inspection.

UVC ELECTRICAL INSTALLATION

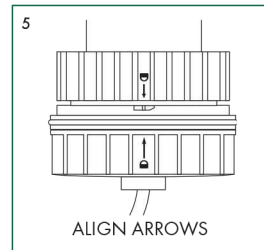

Warning - Direct exposure to UVC light can damage your eyes and skin.

Electrical installation - UVC

Inpond UVC



The cores in the supply cable are coloured in accordance with the following code: **Brown = Live, Blue = Neutral, Green / Yellow = Earth**
In accordance with EN60335-2-109:2010



Warning - A Residual Current Device (RCD), also known as the Residual Current Circuit Breaker (RCCB), with a tripping current not exceeding 30mA must be installed in the supply circuit. A means of disconnection from the supply having a contact separation of at least 3mm in all poles must be incorporated in the wiring

Important: Please note all electrical work on garden lighting and power installations must comply with part P of the building regulations. Failure to comply is a criminal offence. If the installation of this product is not carried out by a competent electrician who is registered under the Part P self-certification scheme then you must notify the local building control department before work begins. For further information and guidance on this matter and other electrical installations in your home that might be covered by the relevant legislation, contact your local authorities building control department.

UVC ELECTRICAL INSTALLATION

For permanent installations to the mains supply, it is necessary to conform to the regulations of the local electricity authority and this would include the use of a metal or plastic conduit to protect the cable.

Attention has been drawn to the fact that special rules may exist concerning the installation of your pond UVC (i.e. local building regulations).

This UVC must not be used in swimming pools, or areas where people are in contact with the water.

Always disconnect the mains electricity supply whilst the equipment is being installed, repaired, maintained or handled. Consult a qualified electrician if in any doubt about wiring this product to the mains supply.



WARNING: Electrical Safety

UVC warning: Dangerous Ultra Violet Radiation. The rays from the UVC lamp are harmful to eyes and skin.

Always turn off UVC electrical supply before any maintenance.

To protect the UVC starter; never immerse in water. Locate the UVC starter (Inpond 3000 part 12 & Inpond 6000/9000 part 11) 1 metre minimum from pond edge.

MAINTENANCE & CLEANING

Polymer wool cartridge

The polymer wool pad may be washed a limited number of times before it starts to lose efficiency and block rapidly.

Replacement packs of polymer wool are available from your retailer and are quick and easy to replace.

See page 15 On how to remove the cartridge easily from the Inpond.

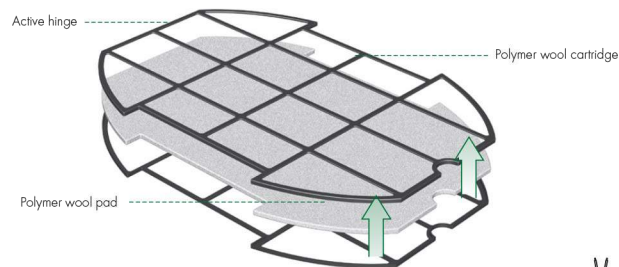

Removing led Lamp

Replacing or removing the lamp can be easily done by unscrewing the lamp screw cap, then the clear cover can come apart. Allowing the LED lamp to be disconnected. See getting to know your Inpond for part descriptions.

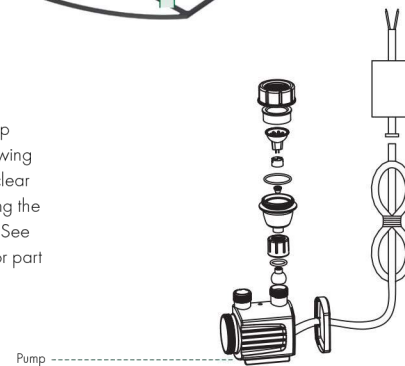

IMPORTANT - Ensure that the mains supply is switched off and the power isolated before removing the lamp cover.

LED Automatic Photo Sensor

- detects when light levels are low/dusk

The LED automatic sensor is positioned on top of the motor body between the outlet and the lamp. Ensure this is kept clean from dirt and algae as it needs sufficient light to activate correctly.

This extremely efficient lamp uses less than 1 watt of electricity which automatically turns on at dusk and off at dawn.

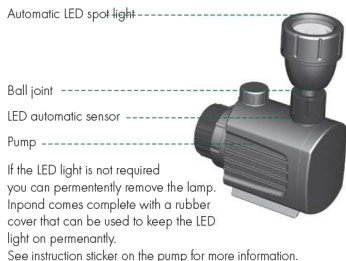

Annual maintenance of the filter

Check for wear. Once a year you should dismantle your Inpond. Dismantle the filter examining all the parts for wear or damage, replacing any parts showing obvious signs of wear and/or damage (see getting to know your filter for replacement codes and parts descriptions on pages 2, 3, 4 & 5)

Annual maintenance of the pump

Check for wear. Once a year you should service your pump. Dismantle pump and examine all parts for wear or damage, replacing any parts that show obvious wear and/or damage (see getting to know your Inpond for parts/description and replacement codes). Particular care should be taken to examine the cable entry points.

Annual maintenance of the UVC

Check for wear. Once a year you should dismantle your Inpond UVC section. Ensure you have disconnected the mains supply before carrying out any maintenance or cleaning. Dismantle the UVC containing all the parts for wear and damage, replacing any parts that show obvious signs of wear and damage (see getting to know your Inpond for parts/description and replacement codes).

Winter Storage

The Inpond can be run in the pond during the winter but care should be taken to ensure that it is fully immersed and cannot freeze solid. If the Inpond is not used during the winter follow the annual maintenance procedure and store frost-free in the house or garage until spring.

Inpond Filter

Cloudy/brown water

- The flow rate / pond turnover is too high or too low. Check that you have correctly calculated the pond volume and that pump flow rate is within limits.
- The filter is not being supplied with water 24 hours a day. Do not turn off your Inpond. Continuous running is needed to maintain a clean and healthy pond.
- The filter foam pads are insufficiently blocked to trap the fine waste. Treat with Blagdon Clear Pond treatment.
- The water is extremely dirty, remove pond waste and leaves - carry out a partial water change.
- Filter is incorrectly sized - refer to filter performance and specification chart.
- The filter foams have not been positioned or replaced correctly, ensure that the foams fit tightly within the filter chamber.

UVC leaks

- Check that the UVC O-ring has been correctly assembled.
- Check that the UVC cap is correctly locked with the yellow quartz sleeve section. Arrows on both caps should be correctly aligned when fitted. See page 16 & 17 on how to correctly install and remove UVC section.

Inpond Pump

Problem

Low flow from pump

1. Follow routine cleaning procedure if no improvement.
2. Follow monthly cleaning procedure.
3. Ensure pipe work is not blocked, leaking or is laid so that it gets crushed or kinked.
4. Keep the height that water is to be pumped from the water surface (called Head) to a minimum. The higher the head the lower the flow rate and the more wear on the pump.
5. Use the largest diameter, smoothest bore pond hose over the shortest distance and keep hose fittings to a minimum. This removes frictional loss of flow and so increases pump flow rates.

Poor Fountain performance

- Reduced height.
- Jets blocked.
Clean flow adjusters and fountain head. Wash under a tap or hose. Pond Pump Cleaner should be used to remove lime scale build-up/waste (see diagram) for improved results.

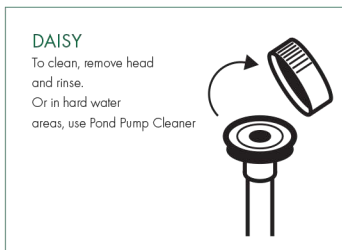

No flow from pump

1. Check power supply is on.
2. Check fuse and wiring (SEE ELECTRICAL INSTALLATION).
3. Follow low flow procedure as above.

If none of the above works contact Interpet (Blagdon) Consumer Advice Department (See Faults problem procedure Page 25).

Green water

- Settlement test the water to ensure that there is no sediment suspended in the water. If there is, follow the brown cloudy water troubleshooting guide.
- In order to check that the UVC lamp is operating: Open the filter unit (see page 15) remove the filter foams and cartridge. Positioned on top of the yellow UVC contact chamber will be a round viewing window where you should see a faint blue light. This operation may need to be carried out at dusk as UVC lamps emit a dim blue light under normal operation. Turning the lamp on and off may aid visual identification. (Ensure the UVC lamp is not more than 6 months old).
- The UVC may be working effectively but the filter foam/media is too clean and is unable to remove the fine coagulated waste. Treat the pond with Clear Pond and do not clean the foams/media until they are blocked.
- The filter is too small for the pond, check your filter selection chart.
- The UVC quartz sleeve is dirty or coated in lime scale. Gently remove the quartz sleeve and clean.
- Follow all cloudy water trouble shooting points.

UVC light not illuminated

- Check all fuses / RCD and electrical connections follow electrical installation

Faults - Problem Procedure

Before returning your Inpond to your dealer or contacting our Consumer Advice Department, please carry out the following steps. This will solve most problems quickly and easily.

1. Ensure electrical procedures have been followed fully. Check fuses and any cable connectors/switch boxes.
2. (a) Follow routine maintenance procedure fully. (b) Check location and connecting your pump details including flow rates. (c) Ensure that your pond volume and pump flow rate meet the maximum pond size recommended for the filter model on the filter performance and specification chart. (d) Follow troubleshooting guide.
3. If there is a mechanical breakdown of the filter or UVC, return to the point of purchase for inspection and advice (You will need proof of purchase).

Guarantee

UV & FILTER

This product is guaranteed against defects in material and workmanship for 3 years from the date of purchase, under normal usage. The guarantee DOES NOT APPLY in case of improper use, negligence, lack of maintenance or accidental damage to either the filter or UVC. If the filter or UVC fails due to a manufacturing fault within this period it will be either repaired or replaced free of charge. Liability is limited to replacement of the faulty product only; no other costs will be reimbursed. The guarantee is not transferable and does not affect your statutory rights. This guarantee does not confer any rights other than those expressly set out above. This guarantee does not cover the filter foams or UVC bulb, which will need replacing when worn or every 6 months. If any parts are needed, spares are available from your retailer.

IMPORTANT

PUMP & LIGHT

This product is guaranteed against defects in material and workmanship for 3 years from date of purchase, under normal usage. This guarantee DOES NOT APPLY in case of improper use, negligence, lack of maintenance or accidental damage either to the pump or the impeller shaft. If the pump fails due to a manufacturing fault within this period it will be either repaired or replaced free of charge. Liability is limited to replacement of the faulty product only, no other costs will be reimbursed. The guarantee is not transferable and does not affect your statutory rights. This guarantee does not confer any rights other than those expressly set out above. Excludes the pump impeller & LED lamp which may require replacing annually. If any parts need replacing, spares are available from your retailer.



You can help protect the environment.

Please remember to respect the local regulations: hand in the non-working electrical equipments to an appropriate waste disposal centre.

Clearwater Guarantee

The Clearwater guarantee will be honoured for 1 year after proof of purchase. Clearwater is guaranteed to a depth of 1m, so that fish are clearly visible.

Clearwater is guaranteed provided:

- You follow all instructions as above.
- Your filter is within the performance guidelines stated.
- You consult the Consumer Advice Email and follow any advice to correct the situation.

See details below. Refunds can only be authorised by Interpet Blagdon.

Consumer Advice contact details

Interpet (Blagdon) Consumer Advice Department
Interpet, Vincent Lane, Dorking, Surrey RH4 3YX England

Telephone: 0845 226 7437

(Monday to Friday 10am to 4pm except Bank Holidays - Time may vary)

Fax: 01306 876712 E-mail: customercare@interpet.co.uk

www.blagdonwatergardening.co.uk

www.interpet.co.uk

inpond

3000 • 6000 • 9000

Manufactured with advanced technology to create a clean and healthy pond for your fish.

IMPORTANT

Please attach proof of purchase to this manual and file in a safe place.



Established over 50 years ago, Blagdon are committed to producing a comprehensive range of high quality and easy to use water gardening equipment. We have an on-going programme of research and development that ensures excellent product performance and value for money for our customers. Our products are brought together with half a century of expertise and knowledge so you can be assured of a successful and creative water garden.



Interpet, Vincent Lane,
Dorking, Surrey, RH4 3YX

Interpet.co.uk
Blagdonwatergardening.co.uk

Leaflet Code: 26/11/15